

PRIME AMPHICHEIRAL KNOTS WITH FREE PERIOD 2

LUISA PAOLUZZI AND MAKOTO SAKUMA

ABSTRACT. We construct prime amphicheiral knots that have free period 2. This settles an open question raised by the second named author, who proved that amphicheiral hyperbolic knots cannot admit free periods and that prime amphicheiral knots cannot admit free periods of order > 2 .

AMS classification: Primary 57M25; Secondary 57M50.

Keywords: prime knot, amphicheiral knot, free period, symmetry.

1. INTRODUCTION

A knot K in the 3-sphere is *amphicheiral* if there exists an orientation-reversing diffeomorphism φ of the 3-sphere which leaves the knot invariant. More precisely the knot is said to be *positive-amphicheiral* (*+amphicheiral* for short) if φ preserves a fixed orientation of K and *negative-amphicheiral* (*-amphicheiral* for short) otherwise. Of course, a knot can be both positive- and negative-amphicheiral. This happens if and only if the knot is both amphicheiral and invertible. Recall that a knot is *invertible* if there exists an orientation-preserving diffeomorphism of the 3-sphere which leaves the knot invariant but reverses its orientation.

A knot K in the 3-sphere is said to have *free period* $n \geq 2$ if there exists an orientation-preserving periodic diffeomorphism f of the 3-sphere of order n which leaves the knot invariant, such that f generates a free $\mathbb{Z}/n\mathbb{Z}$ -action on the 3-sphere.

It was proved by the second named author that amphicheirality and free periodicity are inconsistent in the following sense (see [24, 25]).

- (1) Any amphicheiral prime knot does not have free period > 2 .
- (2) Any amphicheiral hyperbolic knot does not have free period.

On the other hand, it is easy to construct, for any integer $n \geq 2$, a composite amphicheiral knot that has free period n . Thus it was raised in [25] as an open question whether there is an amphicheiral prime knot that has free period 2.

Date: April 9, 2018.

2010 *Mathematics Subject Classification.* Primary 57M25; Secondary 57M50

The first author was supported by JSPS Invitational Fellowship for Research in Japan S17112. The second author was supported by JSPS Grants-in-Aid 15H03620.

The main purpose of this paper is to prove the following theorem which gives an answer to this question.

Theorem 1.1. (1) *For each $\epsilon \in \{+, -\}$, there are infinitely many prime knots with free period 2 that are ϵ -amphicheiral but not $-\epsilon$ -amphicheiral; in particular, they are not invertible.*

(2) *There are infinitely many prime knots with free period 2 that are ϵ -amphicheiral for each $\epsilon \in \{+, -\}$; in particular, they are invertible.*

For the proof of the theorem, we introduce a specific subgroup $\mathbb{G} = \langle \gamma_1, \gamma_2 \rangle$ of the orthogonal group $O(4) \cong \text{Isom}(\mathbf{S}^3)$, generated by two commuting orientation-reversing involutions γ_1 and γ_2 , where γ_1 is a reflection in a 2-sphere, γ_2 is a reflection in a 0-sphere, and $f := \gamma_1\gamma_2$ is a free involution. Consider a \mathbb{G} -invariant hyperbolic link $L = K_0 \cup \mathcal{O}_\mu$ in \mathbf{S}^3 , consisting of a specific \mathbb{G} -invariant component K_0 and a μ -component trivial link \mathcal{O}_μ . Then we prove that given such a link L , we can construct a prime amphicheiral knot K with free period 2, such that the exterior $E(L)$ of L is the root E_0 of the JSJ decomposition of the exterior $E(K)$, i.e. the geometric piece containing the boundary of $E(K)$, where the boundary torus of the tubular neighbourhood of K_0 corresponds to $\partial E(K)$. In fact, we show that each γ_i (to be precise, the restriction of γ_i to $E(L)$) extends to an orientation-reversing diffeomorphism of \mathbf{S}^3 preserving the prime knot K , and f extends to a free involution on \mathbf{S}^3 preserving K . It should be noted that \mathbb{G} does not necessarily extend to a group action on (\mathbf{S}^3, K) . In fact, the extension of γ_1 generically has infinite order in the symmetry group $\pi_0\text{Diff}(\mathbf{S}^3, K)$ (see Remark 2.3).

The proof of Theorem 1.1 is then reduced to producing examples of links L fulfilling the above properties. Of course, while it is not difficult to construct links admitting prescribed symmetries, ensuring that they are hyperbolic can be much more delicate. We will construct three links that will provide examples of knots having different properties. We will give theoretic proofs of the fact that they are hyperbolic, although this can also be checked using the computer program SnapPea [28], SnapPy [8], or the computer verified program HIKMOT [12].

Moreover, we show that any amphicheiral prime knot with free period 2 is constructed in this way (Theorem 4.1). In other words, if K is an amphicheiral prime knot with free period 2, then the root E_0 of the JSJ decomposition of $E(K)$ is identified with $E(L)$ for some \mathbb{G} -invariant link L with the above property. Furthermore, we prove the following theorem which provides some insight on the root E_0 with respect to the \mathbb{G} -action.

Theorem 1.2. *Let K be a prime amphicheiral knot with free period 2 and let $E_0 = E(L) = E(K_0 \cup \mathcal{O}_\mu)$ be its root. Then after an isotopy, L is invariant by the action of \mathbb{G} on \mathbf{S}^3 , and the following hold.*

(1) *L contains*

- *at most two components whose stabiliser is \mathbb{G} , one of which must be K_0 ;*

- at least one pair of components of \mathcal{O}_μ , such that each of the components intersects the 2-sphere $\text{Fix}(\gamma_1)$ transversely in two points, the stabiliser of each of the components is generated by γ_1 , and f interchanges the two components;
- no component with stabiliser generated by f .

(2) Assume that K is positive-amphicheiral. Then K_0 is contained in $\text{Fix}(\gamma_1)$.

(3) Assume that K is negative-amphicheiral. Then K_0 must contain $\text{Fix}(\gamma_2)$ and intersect transversally $\text{Fix}(\gamma_1)$ in two points.

Remark 1.3. In the above theorem, if K is both positive- and negative-amphicheiral, then L admits two different positions with respect to the action of \mathbb{G} . In other words, there are two subgroups \mathbb{G}_+ and \mathbb{G}_- in $\text{Diff}(S^3, L)$ such that (i) both \mathbb{G}_+ and \mathbb{G}_- are conjugate to \mathbb{G} in $\text{Diff}(S^3)$ and (ii) the groups \mathbb{G}_+ and \mathbb{G}_- satisfy the conditions (2) and (3), respectively. In fact, (S^3, L) admits an action of $(\mathbb{Z}/2\mathbb{Z})^3$ such that \mathbb{G}_+ and \mathbb{G}_- correspond to $(\mathbb{Z}/2\mathbb{Z})^2 \oplus 0$ and $0 \oplus (\mathbb{Z}/2\mathbb{Z})^2$, respectively, where $0 \oplus (\mathbb{Z}/2\mathbb{Z}) \oplus 0$ is generated by f .

For a prime knot K , let $\mu(K)$ be the number of boundary components of the root E_0 of the JSJ decomposition of $E(K)$ that correspond to the tori of the JSJ decomposition, i.e., $\mu(K) + 1$ is equal to the number of boundary components of E_0 . Define now μ_+ (respectively μ_-) to be the minimum of $\mu(K)$ over all prime knots K with free period 2 that are positive- (respectively negative-) amphicheiral. The main result of [25] says that $\mu_\pm > 0$. The following theorem determines both μ_+ and μ_- .

Theorem 1.4. *The following hold:*

(1) $\mu_- = 2$. Moreover, if K realises μ_- , i.e., if K is a prime negative-amphicheiral knot with free period 2 such that $E_0 = E(K_0 \cup \mathcal{O}_2)$, then K_0 contains $\text{Fix}(\gamma_2)$ and the stabiliser of each component of \mathcal{O}_2 is generated by γ_1 .

(2) $\mu_+ = 3$. Moreover, if K realises μ_+ , i.e., if K is a prime positive-amphicheiral knot with free period 2 such that $E_0 = E(K_0 \cup \mathcal{O}_3)$, then K_0 is a (necessarily trivial) knot contained in $\text{Fix}(\gamma_1)$, one of the three components of \mathcal{O}_3 is stabilised by \mathbb{G} and thus contains $\text{Fix}(\gamma_2)$, while the stabiliser of the other two components is generated by γ_1 .

We remark that our explicit constructions provide in particular negative- (respectively positive-) amphicheiral knots K with free period 2 such that $\mu(K) = 2$ (respectively $\mu(K) = 3$). We also describe the structure of the subgroup $\text{Isom}^*(E_0)$ of $\text{Isom}(E_0)$ consisting of those elements which extend to a diffeomorphism of (\mathbf{S}^3, K) (Proposition 5.10).

The paper is organised as follows. In Section 2, we show how one can construct prime amphicheiral knots with free period 2 from the exterior of a hyperbolic link with specified properties. In Section 3, we provide examples of such links. In Section 4, we show that the requirement on the links are not only sufficient but

also necessary (Theorem 4.1). This is used in Section 5 to prove Theorems 1.2 and 1.4; Theorem 1.1 is also proved in this section. In Section 6, we refine the arguments in Section 5 and give more detailed information concerning the root E_0 . In particular, we present a convenient description of the link L in case K is positive amphicheiral (Remark 6.2). The final Sections 7, 8, and 9 are technical: there we show that the links introduced in Section 3 are hyperbolic, completing the proof that they fulfill all the desired requirements.

2. CONSTRUCTING THE KNOTS

In this section, we show that the existence of a hyperbolic link with a specified symmetry and some extra properties is sufficient to ensure the existence of prime amphicheiral knots with free period 2. We start by defining the symmetry we want.

Let $\mathbb{G} = \langle \gamma_1, \gamma_2 \rangle$ be the group of isometries of the 3-sphere $\mathbf{S}^3 = \{(z_1, z_2) \in \mathbb{C}^2 \mid |z_1|^2 + |z_2|^2 = 1\}$ with the standard metric, generated by the following two commuting orientation-reversing isometric involutions γ_1 and γ_2 .

$$(1) \quad \gamma_1(z_1, z_2) = (\bar{z}_1, z_2), \quad \gamma_2(z_1, z_2) = (-\bar{z}_1, -z_2).$$

The involution γ_1 is a reflection in the 2-sphere $\mathbf{S}^3 \cap (\mathbb{R} \times \mathbb{C})$, and the involution γ_2 is a reflection in the 0-sphere $\{(\pm i, 0)\}$. The composition $f := \gamma_1 \gamma_2$ is an orientation-preserving free involution $(z_1, z_2) \mapsto (-z_1, -z_2)$. If we identify \mathbf{S}^3 with $\mathbb{R}^3 \cup \{\infty\}$, where ∞ corresponds to the point $(i, 0) \in \mathbf{S}^3$, then γ_1 is an inversion in a unit 2-sphere in \mathbb{R}^3 and γ_2 is an antipodal map with respect to the origin. If we identify \mathbf{S}^3 with $\mathbb{R}^3 \cup \{\infty\}$, where ∞ corresponds to the point $(1, 0) \in \mathbf{S}^3$, then γ_1 is a reflection in a 2-plane in \mathbb{R}^3 and γ_2 has a unique fixed point in each of the two half-spaces defined by the 2-plane.

Definition 2.1. Let $L = K_0 \cup \mathcal{O}_\mu$ be a link. We will say that L provides an *admissible root* if it satisfies the following requirements:

- L is \mathbb{G} -invariant and K_0 is stabilised by the whole group \mathbb{G} .
- \mathcal{O}_μ is a trivial link with μ components.
- L is hyperbolic.

A link L providing an admissible root can be used to construct a prime satellite knot in the following way: remove a \mathbb{G} -invariant open regular neighbourhood of $\mathcal{O}_\mu = \cup_{i=1}^\mu O_i$ and glue non-trivial knot exteriors, $E(K_i)$, $i = 1, \dots, \mu$, along the corresponding boundary components in such a way that the longitude and meridian of O_i are identified with the meridian and longitude of $E(K_i)$ respectively. The image of K_0 in the resulting manifold is a prime knot K in \mathbf{S}^3 .

Note that

$$(\mathbf{S}^3, K) = (E(\mathcal{O}_\mu), K_0) \cup (\cup_{i=1}^\mu (E(K_i), \emptyset)),$$

where $E(\mathcal{O}_\mu)$ is the exterior of \mathcal{O}_μ which is \mathbb{G} -invariant.

We wish to perform the gluing so that the following conditions hold.

- (i) Each element of \mathbb{G} “extends” to a diffeomorphism of (\mathbf{S}^3, K) . To be precise, for each element $g \in \mathbb{G}$, the restriction, \check{g} , of g to $(E(\mathcal{O}_\mu), K_0)$ extends to a diffeomorphism, \hat{g} , of (\mathbf{S}^3, K) .
- (ii) An “extension” \hat{f} of $f = \gamma_1\gamma_2$ to (\mathbf{S}^3, K) is a free involution.

Note that we do not intend to extend the action of \mathbb{G} to (\mathbf{S}^3, K) . In fact, such an extension does not exist generically (see Remarks 2.3 and 5.9, and Proposition 6.3).

To this end we need to choose the knot exterior $E(K_i)$ appropriately according to the stabiliser in \mathbb{G} of the component O_i of the link L .

Case 1. *The stabiliser of O_i is trivial.* In this case, one can choose K_i to be any non-trivial knot in \mathbf{S}^3 . The same knot exterior must be chosen for the other three components of \mathcal{O}_μ in the same \mathbb{G} -orbit as O_i and the gluing must be carried out in a \mathbb{G} -equivariant way. Note that this is possible because the elements of \mathbb{G} map meridians (respectively longitudes) of the components of L to meridians (respectively longitudes).

Case 2. *The stabiliser of O_i is generated by γ_j for some $j \in \{1, 2\}$.* Let T_i be the boundary component of $E(\mathcal{O}_\mu)$ which forms the boundary of a regular neighbourhood of O_i , and let ℓ_i and m_i be the longitude and the meridian curves in $T_i = \partial E(K_i)$ of the knot K_i . Recall that these are the meridian and longitude of O_i respectively. We see that γ_j acts on $H_1(T_i; \mathbb{Z})$ either as

$$(\gamma_j)_* \begin{pmatrix} \ell_i \\ m_i \end{pmatrix} = \begin{pmatrix} \ell_i \\ -m_i \end{pmatrix}$$

or

$$(\gamma_j)_* \begin{pmatrix} \ell_i \\ m_i \end{pmatrix} = \begin{pmatrix} -\ell_i \\ m_i \end{pmatrix}.$$

In the former case, we need to choose K_i to be a positive-amphicheiral knot in \mathbf{S}^3 , while in the latter case we need to choose $E(K_i)$ to be the exterior of a negative-amphicheiral knot. With this choice, the restriction of the involution γ_j to $(E(\mathcal{O}_\mu), K_0)$ extends to a diffeomorphism of $(E(\mathcal{O}_\mu) \cup E(K_i), K_0)$.

This can be seen as follows. Because of the chosen type of chirality of K_i , there is an orientation-reversing diffeomorphism, ν_i , of $E(K_i)$ whose induced action on $H_1(T_i; \mathbb{Z})$ is equal to that of $(\gamma_j)_*$. Then the restrictions of γ_j and ν_i to T_i are smoothly isotopic. So, by using a collar neighbourhood of T_i , we can glue the diffeomorphisms γ_j and ν_i to obtain the desired diffeomorphism of $(E(\mathcal{O}_\mu) \cup E(K_i), K_0)$.

For the other component $O_{i'} = f(O_i)$ of L in the \mathbb{G} -orbit of O_i , we glue a copy of the same knot exterior along $O_{i'}$, so that the free involution extends to a free involution of $(E(\mathcal{O}_\mu) \cup E(K_i) \cup E(K_{i'}), K_0)$, which exchanges $E(K_i)$ with $E(K_{i'})$. By the previous argument, γ_j also extends to a diffeomorphism of $(E(\mathcal{O}_\mu) \cup E(K_i) \cup E(K_{i'}), K_0)$, and so do all elements of \mathbb{G} .

Case 3. *The stabiliser of O_i is generated by f .* This case cannot arise as shown by the following lemma.

Lemma 2.2. *Let L be a link which is invariant by the action of \mathbb{G} . Then no component of L can be stabilised precisely by the cyclic subgroup of \mathbb{G} generated by f .*

Proof. Assume that L_j is a component whose stabiliser contains f . Since the two balls of $\mathbf{S}^3 \setminus \text{Fix}(\gamma_1)$ are exchanged by f , L_j cannot be contained in one of them, and must thus intersect $\text{Fix}(\gamma_1)$. It follows that γ_1 belongs to the stabiliser of L_j , and hence the stabiliser of L_j is the whole group \mathbb{G} . \square

Note that for the conclusion of the lemma to be valid, we do not need to assume that L is hyperbolic.

Case 4. *The stabiliser of O_i is \mathbb{G} .* In this case we choose K_i to be a non-trivial amphicheiral knot with free period 2; recall that, without appealing to Theorem 1.1, there are composite knots with these properties. In fact, the connected sum of two copies of an ϵ -amphicheiral knot is ϵ -amphicheiral and has free period 2 (cf. [24, Theorem 4]). Now note that the action of f on $H_1(T_i)$ is trivial and therefore the actions of γ_1 and γ_2 on $H_1(T_i)$ are identical. Hence we may choose $E(K_i)$ to be the exterior of a positive- or negative-amphicheiral knot accordingly, so that $E(K_i)$ admits an orientation-reversing diffeomorphism, ν_i , such that the action of ν_i on $H_1(T_i)$ is identical with those of γ_1 and γ_2 . Thus both γ_1 and γ_2 extend to diffeomorphisms of $(E(\mathcal{O}_\mu) \cup E(K_i), K_0)$, as in Case 2.

Though the composition of the extensions of γ_1 and γ_2 may not be an involution, we can show that $f = \gamma_1\gamma_2$ extends to a free involution on $(E(\mathcal{O}_\mu) \cup E(K_i), K_0)$. To see this, we use the fact that the strong equivalence class of a free $\mathbb{Z}/n\mathbb{Z}$ -action on a torus T is determined by its *slope*, which is the submodule of $H_1(T; \mathbb{Z}/n\mathbb{Z})$ isomorphic to $\mathbb{Z}/n\mathbb{Z}$, represented by a simple loop on T which is obtained as an orbit of a free circle action in which the $\mathbb{Z}/n\mathbb{Z}$ -action embeds (see [24, Section 2]). Here two actions are *strongly equivalent* if they are conjugate by a diffeomorphism which is isotopic to the identity. Now, as in Case 1, let ℓ_i and m_i be the longitude and the meridian in $T_i = \partial E(K_i)$ of the knot K_i . Then since f gives a free period 2 of the trivial knot O_i , the slope of the action of f on T_i is generated by $\ell_i + m_i$ by [24, Lemma 1.2(3)]. Let f_i be a free involution on $E(K_i)$ which realise the free periodicity of K_i . Then the slope of f_i on T_i is also generated by $\ell_i + m_i$. Thus the restrictions of f and f_i to T_i are strongly equivalent by [24, Lemma 1.1]. Hence, by using a collar neighbourhood of T_i , we can glue these free involutions to obtain a free involution on $(E(\mathcal{O}_\mu) \cup E(K_i), K_0)$.

The above case-by-case discussion shows that, given a link $L = K_0 \cup \mathcal{O}_\mu$ which provides an admissible root, we can construct a knot (\mathbf{S}^3, K) by attaching suitable knot exteriors $\{E(K_i)\}_{1 \leq i \leq \mu}$ to $(E(\mathcal{O}_\mu), K_0)$, such that all elements of \mathbb{G} extend to diffeomorphisms of (\mathbf{S}^3, K) where an extension of f is a free involution. It is

now clear that the resulting knot K is a prime amphicheiral knot and has free period 2.

Remark 2.3. According to Theorem 1.2 (see also Claim 5.2), L must contain a component O_i whose stabiliser is generated by γ_1 , where γ_1 acts on the boundary torus T_i as a reflection in two meridians of O_i . Thus the knot K_i must be positive amphicheiral. The orientation-reversing diffeomorphism ν_i of $E(K_i)$ realising the positive amphicheirality of K_i is not necessarily an involution nor a periodic map. Even if ν_i is an involution, its restriction to T_i is not strongly equivalent to that of γ_1 . In this case, the square of the diffeomorphism obtained by gluing γ_1 and ν_i is a non-trivial Dehn-twist along the JSJ torus T_i . As a consequence, the extension of γ_1 can never be periodic.

3. SOME EXPLICIT EXAMPLES OF LINKS PROVIDING ADMISSIBLE ROOTS

To complete the proof of the existence of prime amphicheiral knots with free period 2 we still need to produce a link satisfying the requirements of Definition 2.1.

In this section we shall define three links, $L_\mu = K_0 \cup \mathcal{O}_\mu$ with $\mu = 2, 3, 6$, and show that they provide admissible roots. The three different links will allow us to produce prime amphicheiral knots with different properties.

3.1. The link L_2 . Consider the link depicted in Figure 1(3). The link was constructed in such a way as to ensure that it admits the desired \mathbb{G} -action in the following way. Consider a fundamental domain for the \mathbb{G} -action, define a tangle inside the domain, and get a link by symmetrising the domain and the tangle it contains thanks to the \mathbb{G} -action.

It is not difficult to see that \mathbb{G} has a fundamental domain which consists in “half a ball”: indeed each of the 3-balls bounded by the 2-sphere $\text{Fix}(\gamma_1)$ forms a γ_2 -invariant fundamental domain for $\langle \gamma_1 \rangle$, and the restriction of the antipodal map γ_2 to each of the 3-ball has half the ball as a fundamental domain. To be even more precise, the half ball can be considered as a cone on a closed disc. The identification induced by the action on its boundary, which consists in gluing the boundary circles of the discs via a rotation of order 2, allows to obtain the global quotient which is a cone on a projective plane: the vertex of the cone is a singular point of order two (image of the fixed-points of γ_2), and the base of the cone is a silvered projective plane (image of the fixed-points of γ_1).

We define a three-component tangle inside the half ball as shown in Figure 1(1). One component is a “trefoil arc” (i.e. a trefoil knot cut at one point): this component will give rise to K_0 which is \mathbb{G} -invariant, and thus contains the vertex of the cone. The other two components are unknotted arcs which are entangled with the first component. The procedure and result of symmetrising the tangle are shown in Figure 1(2) and (3). Because of its very construction it is now clear that L_2 has the required \mathbb{G} -action where K_0 is \mathbb{G} -invariant. It is also clear from the picture that the components O_1 and O_2 of L_2 form a trivial link.

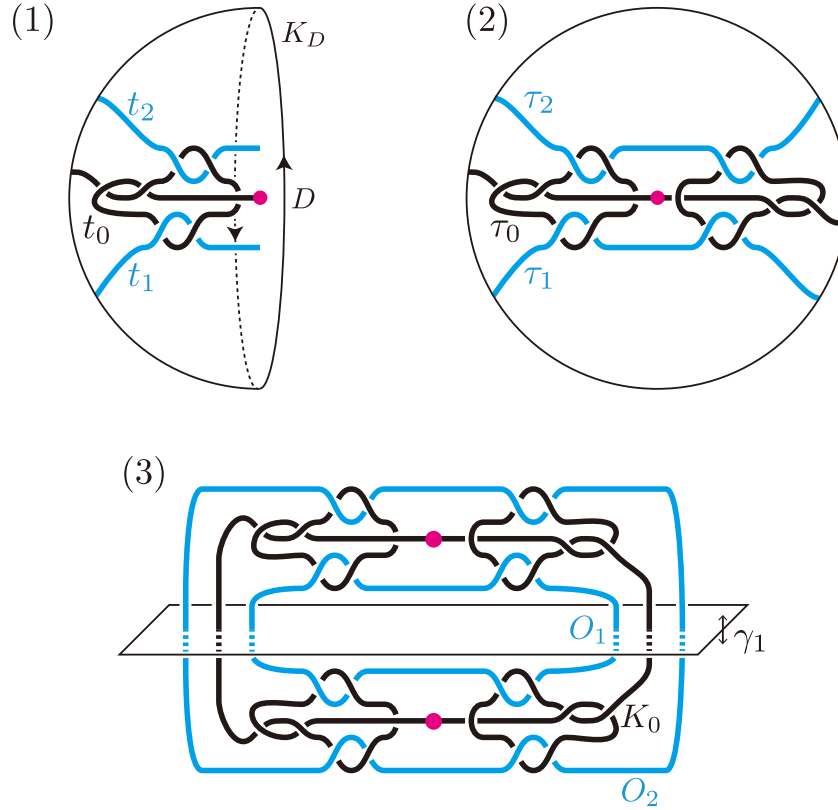

FIGURE 1. (1) The three-string tangle inside the half-ball fundamental domain (top left), (2) the first symmetrisation with respect to the antipodal map (top right), and (3) the resulting link $L_2 = K_0 \cup O_1 \cup O_2$ after symmetrising with respect to the inversion in a sphere.

It remains to show that the link is hyperbolic. The proof of this fact is rather technical and is given in Section 7.

3.2. The link L_3 . As in the previous subsection, we build a \mathbb{G} -symmetric link from a tangle in a fundamental domain for the \mathbb{G} -action, as illustrated in Figure 2.

The resulting link L_3 and its component K_0 are \mathbb{G} -invariant by construction. It is clear from the picture that $O_1 \cup O_2 \cup O_3$ is a trivial link. Hyperbolicity of L_3 is again rather technical to establish and will be shown in Section 8.

We remark that the symmetry group of L_3 is larger than \mathbb{G} . In fact, it contains another reflection γ_3 in a 2-sphere (see Figure 3). As a consequence, L_3 is invariant by the action of another Klein four-group $\mathbb{G}' = \langle \gamma'_1, \gamma'_2 \rangle = r^{-1}\mathbb{G}r$, where r is the $\pi/2$ -rotation about $Fix(\gamma_1) \cap Fix(\gamma_3)$, and $\gamma'_1 = r^{-1}\gamma_1r = \gamma_3$ and $\gamma'_2 = r^{-1}\gamma_2r = r_1r_2r_3$. Notice that the element $h := r^2 = \gamma_1\gamma_3$ is a π -rotation acting as a strong

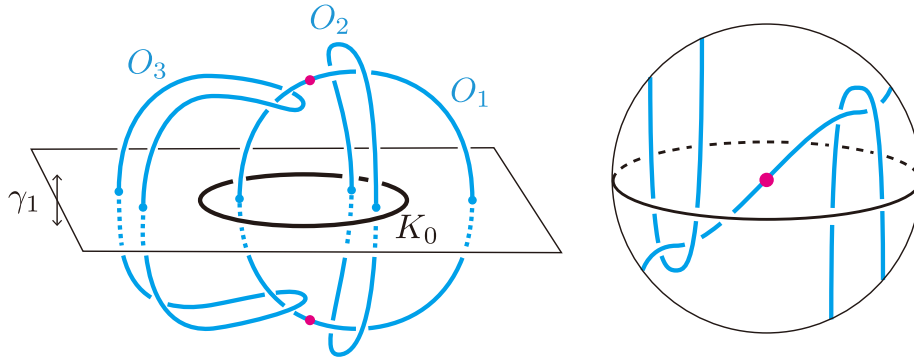

FIGURE 2. The link L_3 pictured on the left is symmetric with respect to γ_1 , the reflection in the horizontal plane. The tangle obtained as the quotient of L_3 by γ_1 is shown on the right: it is left invariant by the central symmetry of the ball, which lifts to the involution γ_2 whose fixed point set consists of the two points of O_1 marked in red.

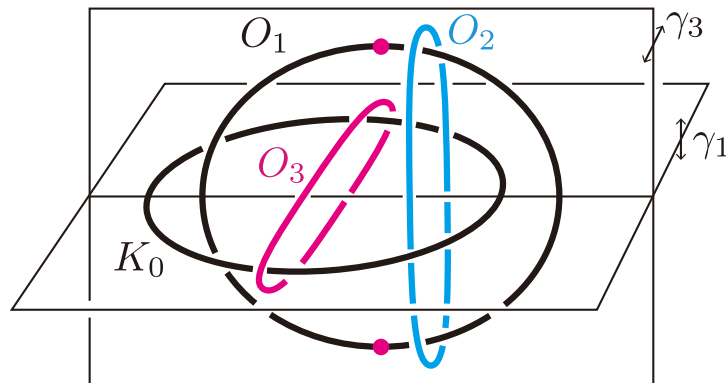

FIGURE 3. An image of L_3 displaying the extra symmetry of the link.

inversion of both K_0 and O_1 . (Here a *strong inversion* of a knot is an orientation-preserving smooth involution of \mathbf{S}^3 preserving the knot whose fixed-point set is a circle intersecting the knot transversely in two points.)

3.3. The link L_6 . In this case, because of the relatively large number of components, the tangle obtained by intersecting the link with a fundamental domain is harder to visualise. Instead of exhibiting the tangle, we give in Figure 4 two pictures of the link showing that the link is symmetric with respect to both γ_1 and γ_2 . Remark that L_6 is a highly symmetric link, namely it is symmetric with respect to three more reflections in vertical planes perpendicular to $\text{Fix}(\gamma_1)$, that is the plane of projection in Figure 4. Observe that the product of two reflections

in these vertical planes results in a $2\pi/3$ -rotation, while the product of one of these reflections with γ_1 is a π -rotation acting as a strong inversion of K_0 .

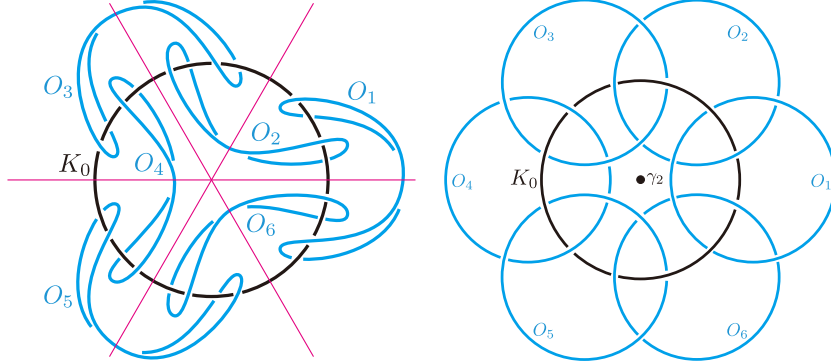

FIGURE 4. Two diagrams of the link L_6 showing the presence of different symmetries. On the left, the link is symmetric with respect to the plane of projection: this symmetry corresponds to γ_1 . The pink lines are the axis of the π -rotations acting as a strong inversions on K_0 : they coincide with the intersection of $\text{Fix}(\gamma_1)$ with the fixed-point sets of the other reflections that leave L_6 invariant. On the right, the link is symmetric with respect to a central reflection corresponding to γ_2 .

Once more, we postpone the proof that L_6 is hyperbolic to Section 9, where we will also see that this example can be generalised to give an infinite family of links providing admissible roots.

4. STRUCTURE OF PRIME AMPHICHEIRAL KNOTS WITH FREE PERIOD 2

In this section, we show that any prime amphicheiral knot with free period 2 is constructed as in Section 2.

Theorem 4.1. *Let K be a prime amphicheiral knot with free period 2. Then there is a link $L = K_0 \cup \mathcal{O}_\mu$ which provides an admissible root and satisfies the following conditions.*

- (1) *There are non-trivial knots K_i ($i = 1, \dots, \mu$) such that*

$$(\mathbf{S}^3, K) = (E(\mathcal{O}_\mu), K_0) \cup (\cup_{i=1}^\mu (E(K_i), \emptyset)).$$

Here, if a component O_i of \mathcal{O}_μ is stabilised by γ_j for some $j = 1$ or 2 , then the knot K_i is negative-amphicheiral or positive-amphicheiral according to whether γ_j preserves or reverses a fixed orientation of O_i .

- (2) *For each element g of \mathbb{G} , its restriction to $(E(\mathcal{O}_\mu), K_0)$ extends to a diffeomorphism of (\mathbf{S}^3, K) , which we call an extension of g . Moreover some extension of $f = \gamma_1\gamma_2 \in \mathbb{G}$ is a free involution on \mathbf{S}^3 . Furthermore, if K is*

ϵ -amphicheiral, then an extension of γ_1 or γ_2 realises the ϵ -amphicheirality of K .

Let K be a prime amphicheiral knot with free period 2. Then as already observed, it follows from [25] that the exterior $E(K)$ of K admits a nontrivial JSJ decomposition. Let E_0 be the root of the decomposition, i.e. the geometric piece containing the boundary, and let E_i ($1 \leq i \leq \mu$) be the closure of the components of $E(K) \setminus E_0$. Then E_0 is identified with the exterior of a link $L = K_0 \cup \mathcal{O}_\mu$ where $\mathcal{O}_\mu = \cup_{i=1}^\mu O_i$ is a μ -component trivial link, and E_i is identified with a knot exterior $E(K_i)$ for each i with $1 \leq i \leq \mu$ (see e.g. [24, Lemma 2.1]).

We show that L provides an admissible root in the sense of Definition 2.1, namely, E_0 is hyperbolic and, after an isotopy, both L and K_0 are \mathbb{G} -invariant.

We first prove that the root E_0 is hyperbolic. Otherwise, E_0 is a Seifert fibered space embedded in $E(K)$ with at least two (incompressible) boundary components and so E_0 is a composing space or a cable space (see [14, Lemma VI.3.4] or [13, Lemma IX.22]). Since K is prime, E_0 is not a composing space. So E_0 is a cable space and hence K is a cable knot. However, a cable knot cannot be amphicheiral, a contradiction. Though this fact should be well known, we could not find a reference, so we include a proof for completeness.

Lemma 4.2. *A cable knot is not amphicheiral.*

Proof. Let K be a (p, q) -cable of some knot, where p is a positive integer greater than 1 and q is an integer relatively prime to p . Then the root E_0 of the JSJ decomposition of $E(K)$ is the Seifert fibered space with base orbifold an annulus with one cone point, such that the singular fiber has index (p, q) . If K is amphicheiral, then E_0 admits an orientation-reversing diffeomorphism, γ , and we may assume that γ preserves the Seifert fibration (see e.g. [27, Theorem 3.9]). Hence we have $q/p \equiv -q/p \in \mathbb{Q}/\mathbb{Z}$, and so $p = 2$. Thus E_0 is identified with the exterior of the pretzel link $P(2, -2, q)$. Since γ is a restriction of a diffeomorphism of (\mathbf{S}^3, K) to E_0 , it extends to a diffeomorphism of $(\mathbf{S}^3, P(2, -2, q))$, which reverse the orientation of \mathbf{S}^3 . This contradicts the fact that $P(2, -2, q)$ is not amphicheiral. Here the last fact can be seen, for example, by using [26, Theorem 4.1]. \square

Let $\text{Isom}^*(E_0)$ be the subgroup of the isometry group of the complete hyperbolic manifold E_0 consisting of those elements, g , which extend to a diffeomorphism of (\mathbf{S}^3, K) . (To be precise, we identify E_0 with the non-cuspidal part of a complete hyperbolic manifold.) Denote by $\text{Isom}_+^*(E_0)$ the subgroup of $\text{Isom}^*(E_0)$ consisting of elements whose extensions to (\mathbf{S}^3, K) preserve the orientation of both \mathbf{S}^3 and K . Then we have the following lemma, which holds a key to the main result in this section. Thus we include a proof, even though it follows from [24, the last part of the proof of Lemma 2.2].

Lemma 4.3. (1) *The action of $\text{Isom}^*(E_0)$ on E_0 extends to a smooth action on (\mathbf{S}^3, L) .*

(2) $\text{Isom}_+^*(E_0)$ is a finite cyclic group.

Proof. (1) Let ℓ_i and m_i , respectively, be the longitude and the meridian of the knot K_i with $E_i = E(K_i)$ ($1 \leq i \leq \mu$). Recall that they are the meridian and the longitude of O_i , respectively. Since each element of $g \in \text{Isom}^*(E_0)$ extends to a diffeomorphism of (\mathbf{S}^3, K) , it follows that if $g(E_i) = E_j$ then $g(\ell_i) = \pm \ell_j$ and so g maps the meridian of O_i to the meridian (possibly with reversed orientation) of O_j . Hence the action of $\text{Isom}^*(E_0)$ on E_0 extends to an action on (\mathbf{S}^3, L) .

(2) If $\text{Isom}_+^*(E_0)$ is not cyclic, then the restriction of the extended action to K_0 is not effective, i.e., there is a nontrivial element, g , of $\text{Isom}_+^*(E_0)$ whose extension, \bar{g} , to $(\mathbf{S}^3, K_0 \cup \mathcal{O}_\mu)$ is a nontrivial periodic map with $\text{Fix}(\bar{g}) = K_0$. By the positive solution of the Smith conjecture [20], $\text{Fix}(\bar{g})$ is a trivial knot, and \bar{g} gives a cyclic periodicity of the trivial link \mathcal{O}_μ . By [23, Theorem 1], such periodic maps are “standard”, and so there are mutually disjoint discs D_i ($1 \leq i \leq \mu$) in \mathbf{S}^3 with $\partial D_i = O_i$ such that, for each $i \in \{1, \dots, \mu\}$, either (i) $\bar{g}(D_i) = D_i$, so that $\text{Fix}(\bar{g})$ intersects D_i transversely in a single point, or (ii) $\bar{g}(D_i) = D_j$ for some $j \neq i$. If (ii) happens for some i , then D_i is disjoint from $\text{Fix}(\bar{g}) = K_0$ and $\mathcal{O}_\mu - O_i$; so the torus T_i is compressible in E_0 , a contradiction. Hence the link $K_0 \cup \mathcal{O}_\mu$ is as illustrated in Figure 5 and therefore E_0 is a composing space, a contradiction. \square

Remark 4.4. We wish to stress that the proof of Lemma 4.3 implies that the extension of $\text{Isom}_+^*(E_0)$ to (\mathbf{S}^3, L) must act effectively on K_0 .

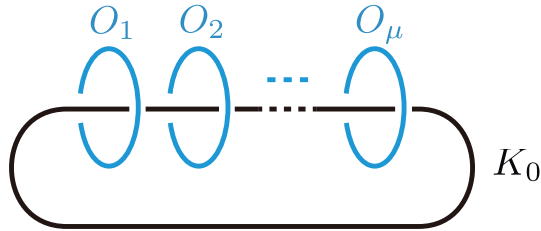

FIGURE 5. A connected sum of Hopf links.

Let γ be a diffeomorphism of (\mathbf{S}^3, K) which realises the amphicheirality of K , and let f be a free involution of (\mathbf{S}^3, K) . After an isotopy γ preserves E_0 and so determines a self-diffeomorphism of E_0 . We will denote by $\check{\gamma}$ the orientation-reversing isometry of E_0 isotopic to this diffeomorphism. By [1, 24], we may assume that the involution f restricts to an isometry \check{f} of E_0 . We denote by $\bar{\gamma}$ and \bar{f} the periodic diffeomorphisms of (\mathbf{S}^3, L) obtained as extensions of $\check{\gamma}$ and \check{f} , respectively, whose existence is guaranteed by Lemma 4.3.

Lemma 4.5. *The diffeomorphism \bar{f} is a free involution of \mathbf{S}^3 .*

Proof. By construction, \bar{f} is an involution which acts freely on E_0 . If \bar{f} has a fixed point, it must occur inside a regular neighbourhood of some component O_i .

Moreover, the fixed-point set must coincide with an O_i which is \bar{f} -invariant. It follows that the slope of \bar{f} along O_i is the meridian. Since the meridian of O_i coincides with the longitude of $E_i = E(K_i)$, the action of f on $E(K_i)$ cannot be free by [24, Lemma 1.2(3)], against the assumption. \square

Lemma 4.6. *We can choose the diffeomorphism γ of (\mathbf{S}^3, K) giving amphicheirality of K so that the corresponding isometry $\check{\gamma}$ of E_0 satisfies the condition that the subgroup $\langle \check{\gamma}, \check{f} \rangle$ of $\text{Isom}(E_0)$ is isomorphic to $(\mathbb{Z}/2\mathbb{Z})^2$. Moreover, the new γ preserves or reverses the orientation of K according to whether the original γ preserves or reverses the orientation of K .*

Proof. Since $\text{Isom}(E_0)$ is the isometry group of a hyperbolic manifold with finite volume, it is a finite group. The element $\check{\gamma}$ reverses the orientation of the manifold, so it must have even order and, up to taking an odd power, we can assume that its order is a power of 2. The cyclic subgroup $\text{Isom}_+^*(E_0)$ of $\text{Isom}^*(E_0)$ is clearly normal. It contains the subgroup generated by \check{f} , which is its only subgroup of order 2. It follows that the subgroup generated by \check{f} is normalised by $\check{\gamma}$, and hence \check{f} and $\check{\gamma}$ commute. If the order of $\check{\gamma}$ is 2 we are done. Otherwise, $\check{\gamma}^2$ belongs to the cyclic group $\text{Isom}_+^*(E_0)$, and \check{f} is a power of $\check{\gamma}$. Note that the periodic map $\bar{\gamma}$ of (\mathbf{S}^3, L) obtained as the extension of $\check{\gamma}$ reverses the orientation of \mathbf{S}^3 and hence it has a nonempty fixed point set. Thus $\bar{\gamma}^2$ also has a nonempty fixed point set, and so does \bar{f} , a contradiction. Hence $\langle \check{\gamma}, \check{f} \rangle \cong (\mathbb{Z}/2\mathbb{Z})^2$. The last assertion is obvious from the construction. \square

Consider the subgroup $\langle \check{\gamma}, \check{f} \rangle$ of $\text{Isom}(E_0)$ in the above lemma, and let $\langle \bar{f}, \bar{\gamma} \rangle$ be its extension to a group action on (\mathbf{S}^3, L) . The main result of [9] implies that $\langle \bar{f}, \bar{\gamma} \rangle$ is conjugate, as a subgroup of $\text{Diff}(S^3)$, to a subgroup $\bar{\mathbb{G}}$ of the orthogonal group $O(4) \cong \text{Isom}(\mathbf{S}^3)$. By using the facts that \bar{f} is a free involution and that $\bar{\gamma}$ descends to an orientation-reversing involution on S^3/\bar{f} , we may assume $\bar{\mathbb{G}}$ is equal to the group $\mathbb{G} = \langle \gamma_1, \gamma_2 \rangle$ (cf. [16]). Thus we may assume $L = K_0 \cup \mathcal{O}_\mu$ is \mathbb{G} -invariant, and it provides an admissible root in the sense of Definition 2.1. The remaining assertions of Theorem 4.1 follow from the arguments in Section 2.

5. PROOFS OF THEOREMS 1.1, 1.2, AND 1.4

Let K be a prime amphicheiral knot with free period 2. Then by Theorem 4.1, there is a link $L = K_0 \cup \mathcal{O}_\mu$ which provides an admissible root and non-trivial knots K_i ($i = 1, \dots, \mu$) such that

$$(\mathbf{S}^3, K) = (E(\mathcal{O}_\mu), K_0) \cup (\cup_{i=1}^\mu (E(K_i), \emptyset)).$$

In particular, L is \mathbb{G} -invariant and the root E_0 of the JSJ decomposition of $E(K)$ is identified with $E(L) = E(K_0 \cup \mathcal{O}_\mu)$ where $\mu = \mu(K)$.

We will start with the proof of Theorem 1.2: each point of the theorem will be proved as a claim in this section.

Claim 5.1. *L contains at most two components whose stabiliser is the whole group \mathbb{G} . These components are either a great circle in the 2-sphere $\text{Fix}(\gamma_1)$, or a knot, either trivial or composite, that meets $\text{Fix}(\gamma_1)$ and contains the two fixed points of γ_2 .*

Here by a *great circle* we mean an embedded circle in the 2-sphere $\text{Fix}(\gamma_1)$ which is invariant by the antipodal map induced by f on $\text{Fix}(\gamma_1)$.

Proof. Let L_i be a component which is left invariant by \mathbb{G} . If L_i is contained in $\text{Fix}(\gamma_1)$ then it must be a trivial knot which is a great circle of $\text{Fix}(\gamma_1)$. Since the 2-sphere $\text{Fix}(\gamma_1)$ cannot contain two mutually disjoint great circles, no other component contained in $\text{Fix}(\gamma_1)$ can have \mathbb{G} as stabiliser. Assume now that L_i is not contained in $\text{Fix}(\gamma_1)$. Since its stabiliser is \mathbb{G} , L_i cannot be contained in one of the two balls of $\mathbf{S}^3 \setminus \text{Fix}(\gamma_1)$. As a consequence, it intersects $\text{Fix}(\gamma_1)$ transversally in two antipodal points, and each of the two balls of $\mathbf{S}^3 \setminus \text{Fix}(\gamma_1)$ in an arc. Since each of these arcs is left invariant by γ_2 , it must contain one of the two fixed points of γ_2 . Of course, at most one component of L can contain $\text{Fix}(\gamma_2)$. Since the two arcs are exchanged by γ_1 , it follows that they are both unknotted, in which case L_i is trivial, or both knotted, in which case L_i is composite. \square

Claim 5.2. *L contains at least one pair of components of \mathcal{O}_μ , such that (i) each of the components intersects the 2-sphere $\text{Fix}(\gamma_1)$ transversely in two points, (ii) the stabiliser of each of the components is generated by γ_1 , and (iii) f interchanges the two components.*

Proof. Since L is hyperbolic, we can assume that γ_1 acts as a hyperbolic isometry on its complement. It follows that each component of $\text{Fix}(\gamma_1) \setminus L$ is a totally geodesic surface in the hyperbolic manifold $\mathbf{S}^3 - L$. Thus no component of $\text{Fix}(\gamma_1) \setminus L$ is a sphere, a disc, or an annulus. On the other hand, if a component of L is not disjoint from the 2-sphere $\text{Fix}(\gamma_1)$, then it is either contained in $\text{Fix}(\gamma_1)$ or intersects $\text{Fix}(\gamma_1)$ transversely in two points. (In fact, if a component of L intersects transversely $\text{Fix}(\gamma_1)$ at a point, then it is γ_1 -invariant and so it intersects $\text{Fix}(\gamma_1)$ transversely in precisely two points.) Now the claim follows from the fact that either (i) $\text{Fix}(\gamma_1)$ contains no component of L , so that $\text{Fix}(\gamma_1) \setminus L$ is a punctured sphere with at least three (actually four) punctures, or (ii) contains some components of L in which case at least two components of $\text{Fix}(\gamma_1) \setminus L$ are punctured discs with at least two punctures. \square

Claim 5.3. *L contains no component with stabiliser generated by f .*

This was proved in Lemma 2.2.

Claim 5.4. (1) If K is positive-amphicheiral, then K_0 must be contained in $\text{Fix}(\gamma_1)$.

(2) If K is negative-amphicheiral, then K_0 must contain $\text{Fix}(\gamma_2)$ and intersect transversally $\text{Fix}(\gamma_1)$ in two points.

Proof. By assumption, K_0 is \mathbb{G} -invariant, so it must be as described in Claim 5.1. Consider the action induced by \mathbb{G} on $H_1(K_0; \mathbb{Z})$. Since $f \in \mathbb{G}$ is a free involution of \mathbf{S}^3 , the action of f on $H_1(K_0; \mathbb{Z})$ is trivial, so the actions of γ_1 and γ_2 on it coincide. It is now easy to see that (i) if K_0 is contained in $\text{Fix}(\gamma_1)$ then γ_1 acts trivially on $H_1(K_0; \mathbb{Z})$, and (ii) if K_0 meets $\text{Fix}(\gamma_1)$ transversally then γ_1 acts on $H_1(K_0; \mathbb{Z})$ as multiplication by -1 . Since ϵ -amphicheirality of K is realised by an extension of γ_1 or γ_2 by Theorem 4.1, we obtain the desired result. \square

This ends the proof of Theorem 1.2.

We now explain Remark 1.3. Suppose that the prime knot K with free period 2 is both positive- and negative-amphicheiral. Since $\text{Isom}_+^*(E_0)$ is a finite cyclic group by Lemma 4.3(2), there is a unique element $f \in \text{Isom}^*(E_0)$ which extends to a smooth involution of (S^3, K) realising the free period 2. For $\epsilon \in \{+, -\}$, let γ_ϵ be the order 2 element of $\text{Isom}^*(E_0)$ which realises the ϵ -amphicheirality of K , such that $\langle f, \gamma_\epsilon \rangle \cong (\mathbb{Z}/2\mathbb{Z})^2$ (cf. Lemma 4.6). Now recall that the finite group $\text{Isom}^*(E_0)$ extends to an action of (\mathbf{S}^3, L) by Lemma 4.3, and so we identify it with a finite subgroup of $\text{Diff}(\mathbf{S}^3, L)$. Then $\gamma_+\gamma_-$ preserves the orientation of \mathbf{S}^3 and reverses the orientation of the component K_0 , and so it realises the invertibility of K_0 . Since $(\gamma_+\gamma_-)^2$ acts on K_0 as the identity map, the periodic map $(\gamma_+\gamma_-)^2$ must be the identity map according to Remark 4.4. Thus $(\gamma_+\gamma_-)^2 = 1$ in $\text{Isom}^*(E_0)$. Hence we see $\langle f, \gamma_+, \gamma_- \rangle \cong (\mathbb{Z}/2\mathbb{Z})^3$. The main result of [9] guarantees that, as a subgroup of $\text{Isom}(\mathbf{S}^3)$, this group is smoothly conjugate to a subgroup of $\text{Isom}(\mathbf{S}^3)$. Remark 1.3 now follows from this fact.

We need the following lemma in the proof of Theorem 1.4.

Lemma 5.5. *Let $L = K_0 \cup \mathcal{O}_2$ be a three component link providing an admissible root. Then K_0 cannot be contained in the 2-sphere $\text{Fix}(\gamma_1)$.*

Proof. Assume by contradiction that L is a link with three components providing an admissible root and such that K_0 is contained in $S := \text{Fix}(\gamma_1)$. Recall that, because of Claim 5.2, each component of \mathcal{O}_2 must intersect S transversally in two points. Thus S gives a 2-bridge decomposition of \mathcal{O}_2 . (For terminology and standard facts on 2-bridge links, we refer to [17, Section 2].) By the uniqueness of the 2-bridge spheres or by the classification of 2-bridge spheres, S is identified with the standard 2-bridge sphere of the 2-bridge link of slope $1/0$. The knot K_0 is an essential simple loop on the 4-times punctured sphere $S \setminus \mathcal{O}_2$, and the isotopy type of any such loop is completely determined by its slope $s \in \mathbb{Q} \cup \{1/0\}$. We can easily check that the involution γ_2 sends a loop of slope s to a loop of a slope of slope $-s$. Hence the slope of K_0 is either 0 or $1/0$. According to whether the slope is 0 or $1/0$, the link $L = K_0 \cup \mathcal{O}_2$ is the connected sum of two Hopf links or 3-component trivial link, a contradiction. \square

We shall now give the proof of Theorem 1.4. Claim 5.2 shows that $\mu_-, \mu_+ \geq 2$. The link L_2 defined in Section 3, on the other hand, shows that $\mu_- \leq 2$. In fact,

both γ_1 and γ_2 act on the component K_0 by reversing its orientation, they extend to diffeomorphisms of (\mathbf{S}^3, K) which give negative-amphicheirality of the knot K . The first part of the theorem now follows from Claims 5.2 and 5.4.

For the second part, once again the link L_3 defined in Section 3 shows that $\mu_+ \leq 3$. Lemma 5.5 assures that $\mu_+ = 3$. In fact, both γ_1 and γ_2 act on the component K_0 by preserving its orientation, they extend to diffeomorphisms of (\mathbf{S}^3, K) which give positive-amphicheirality of the knot K . Now the second part of the theorem follows again from Claims 5.2 and 5.4.

We pass now to the proof of Theorem 1.1. Assuming the hyperbolicity of the links L_μ with $\mu = 2, 3, 6$, which is proved in Sections 7, 8 and 9, the existence of prime, amphicheiral knots with free period 2 was established in Section 3. To finish the proof of Theorem 1.1, we only need to check that we can find prime amphicheiral knots admitting free period 2 that are:

- (1) negative-amphicheiral but not positive-amphicheiral;
- (2) positive-amphicheiral but not negative-amphicheiral;
- (3) positive- and negative-amphicheiral at the same time, that is amphicheiral and invertible.

We show why these statements hold by proving a series of claims.

Claim 5.6. *The prime amphicheiral knots whose root is the exterior of L_2 are negative-amphicheiral and cannot be positive-amphicheiral.*

Proof. Since γ_1 acts on K_0 by reversing its orientation, the extensions of both γ_1 and γ_2 act by inverting K , which is thus negative-amphicheiral. Assume now by contradiction that K is also positive-amphicheiral. According to Theorem 1.2, L_2 must admit another action \mathbb{G}' of the Klein four group, containing a reflection γ'_1 in a 2-sphere $\text{Fix}(\gamma'_1)$, such that K_0 is contained in $\text{Fix}(\gamma'_1)$. This is however impossible for K_0 is not trivial. \square

Claim 5.7. *The prime amphicheiral knots whose root is the exterior of L_3 are positive-amphicheiral. If the knots K_i , $i = 1, 2, 3$, are all positive-amphicheiral but none of them is negative-amphicheiral, then K itself is not negative-amphicheiral.*

Proof. The fact that K is positive-amphicheiral can be seen as in Claim 5.6. Observe that γ_1 acts on each O_i by reversing its orientation. As a consequence, each $E(K_i)$ must be the exterior of a positive-amphicheiral knot, i.e., each K_i must be positive-amphicheiral. We assume now that each K_i is not negative-amphicheiral. Suppose by contradiction that K is negative-amphicheiral. Then, by Theorem 1.2, L_3 admits another action $\mathbb{G}' = \langle \gamma'_1, \gamma'_2 \rangle$ of the Klein four-group such that K_0 contains $\text{Fix}(\gamma'_2) \cong \mathbf{S}^0$. Since \mathcal{O}_3 has three components, precisely one of them, say O_j , for a $j \in \{1, 2, 3\}$, must be \mathbb{G}' -invariant and, according to Claim 5.1, it must be contained in the 2-sphere $\text{Fix}(\gamma'_2)$. Since γ'_1 acts trivially on the first integral homology groups of such components, K_j must be negative-amphicheiral against the assumption. \square

Claim 5.8. *Let K be a prime amphicheiral knot admitting free period 2 whose root is the exterior of L_μ with $\mu = 3$ or 6, that is constructed as in Section 2 by using the symmetry \mathbb{G} .*

(1) *If $\mu = 3$ and K_1 is invertible, then K is invertible.*

(2) *If $\mu = 6$ and all K_i are copies of the same negative-amphicheiral knot, then K is invertible.*

Proof. (1) Consider the link L_3 . Then, by construction of the knot K , K_1 is a positive-amphicheiral knot admitting free period 2, and K_2 and K_3 are copies of a positive-amphicheiral knot. As noted in Subsection 3.2, L is invariant by the action of the group $\hat{\mathbb{G}} = \langle \gamma_1, \gamma_2, \gamma_3 \rangle < \text{Isom}(\mathbf{S}^3)$, where γ_i are orientation-reversing involutions as illustrated in Figure 3. Note that $\hat{\mathbb{G}}$ is the direct product of the group $\mathbb{G} = \langle \gamma_1, \gamma_2 \rangle$ and the order 2 cyclic group generated by $h := \gamma_1\gamma_3$. Then h reverses the orientations of K_0 and O_1 , and preserves the orientations of O_2 and O_3 . The stabiliser in $\hat{\mathbb{G}}$ of O_j is equal to $\hat{\mathbb{G}}$ or $\langle \gamma_1, h \rangle$ according to whether $j = 1$ or $j \in \{2, 3\}$. Since h acts on $H_1(T_j; \mathbb{Z})$ ($j = 2, 3$) trivially, there is no obstruction in extending h to $E(K_j)$ ($j = 2, 3$). On the other hand, h acts on $H_1(T_1; \mathbb{Z})$ as $-I$. Thus if K_1 is invertible, then h extends to a diffeomorphism of (\mathbf{S}^3, K) . The extended h gives invertibility of K .

(2) Consider the link L_6 . Then L_6 is invariant by the group $\tilde{\mathbb{G}} = \langle \gamma_1, \gamma_2, \gamma_3 \rangle < \text{Isom}(\mathbf{S}^3)$, where γ_3 is the reflection in the vertical plane intersecting the projection plane in the horizontal pink line in Figure 4. If all K_i are copies of the same negative-amphicheiral knot, then each of γ_3 and ρ extends to a diffeomorphism of (\mathbf{S}^3, K) , and hence every element of $\tilde{\mathbb{G}}$ extends to a diffeomorphism of (\mathbf{S}^3, K) . We can observe that any extension of $h := \gamma_1\gamma_3$ realises the invertibility of K . \square

The proof of Theorem 1.1 is now complete.

Remark 5.9. (1) In the situation described in Claim 5.8, the involution $h = \gamma_1\gamma_3$ extends to a diffeomorphism \hat{h} of (\mathbf{S}^3, K) which realises the invertibility of the knot. However, any extension \hat{h} of h (to be precise, the restriction of h to $E(L_\mu)$) to (\mathbf{S}^3, K) cannot be an involution. We explain this in the case where the root of K is the exterior of L_3 . In this case h stabilises all components of L_3 , and acts as a π -rotation on each of the components O_2 and O_3 . Thus, for $i = 2, 3$, the restriction of h to $T_i = \partial N(O_i)$ is an orientation-preserving free involution whose slope is the longitude of O_i . This means that h acts on $E(K_i)$, $i = 2, 3$ by preserving the meridian of $E(K_i)$. The positive solution to the Smith conjecture implies that \hat{h} cannot have finite order. The same argument works for the case when the root of K is the exterior of L_6 .

(2) Consider now the element $\gamma_2\gamma_1' = fh$. If the root of K is the exterior of L_6 , then fh extends to a strong inversion of K . To see this, it suffices to observe that this element does not stabilise any component of L_6 other than K_0 . In the case where the root of K is the exterior of L_3 , fh is a strong inversion provided that

the knot K_1 is strongly invertible, since O_1 meets $\text{Fix}(fh)$ and is left invariant by fh , while the components O_2 and O_3 are exchanged.

The following result is a consequence of the discussion in the previous section and of Theorem 1.2.

Proposition 5.10. *Assume K is a prime amphicheiral knot with free period 2 and let E_0 be its root which can be identified with the exterior of a link $L = K_0 \cup \mathcal{O}$. Let $2n \geq 2$ be the order of the cyclic group $\text{Isom}_+^*(E_0)$. Then precisely one of the following situations occurs:*

- (1) K is positive-amphicheiral but not negative-amphicheiral and $\text{Isom}^*(E_0)$ is isomorphic to $\mathbb{Z}/2n\mathbb{Z} \times \mathbb{Z}/2\mathbb{Z}$;
- (2) K is negative-amphicheiral but not positive-amphicheiral and $\text{Isom}^*(E_0)$ is isomorphic to the dihedral group $\mathbb{Z}/2n\mathbb{Z} \rtimes \mathbb{Z}/2\mathbb{Z}$;
- (3) K is invertible and $\text{Isom}^*(E_0)$ is isomorphic to the semi-direct product $\mathbb{Z}/2n\mathbb{Z} \rtimes (\mathbb{Z}/2\mathbb{Z} \times \mathbb{Z}/2\mathbb{Z})$ where one copy of $\mathbb{Z}/2\mathbb{Z}$ acts dihedrally on $\mathbb{Z}/2n\mathbb{Z}$ and the other trivially.

Proof. Let $\tilde{\gamma}$ be an element in $\text{Isom}^*(E_0)$ which reverses the orientation of E_0 . We saw in Lemma 4.6 that, up to taking an odd power, we can choose $\tilde{\gamma}$ to be of order 2. This means that if K is not invertible the exact sequence

$$1 \longrightarrow \text{Isom}_+^*(E_0) \longrightarrow \text{Isom}^*(E_0) \longrightarrow \mathbb{Z}/2\mathbb{Z} \longrightarrow 1$$

splits and it is enough to understand how $\mathbb{Z}/2\mathbb{Z}$ acts on $\text{Isom}_+^*(E_0)$. To conclude it suffices to observe that $\text{Isom}^*(E_0)$ acts on the circle K_0 and the action of $\hat{\gamma}$ is effective if and only if it reverses the orientation of the circle and thus acts dihedrally on $\text{Isom}_+^*(E_0)$.

If K is invertible, the argument is the same provided we can show that the exact sequence

$$1 \longrightarrow \text{Isom}_+^*(E_0) \longrightarrow \text{Isom}^*(E_0) \longrightarrow \mathbb{Z}/2\mathbb{Z} \times \mathbb{Z}/2\mathbb{Z} \longrightarrow 1$$

splits again. This, however, follows easily from Remark 1.3. \square

6. MORE INFORMATION ON THE ROOT $E_0 = E(L)$

In this section, we give refinements of the arguments in the previous section, and present more detailed results on the structure of the root $E_0 = E(L)$.

We first give a characterisation of the links $L = K_0 \cup \mathcal{O}_\mu$ that provide an admissible root of a positive amphicheiral knot. Recall that, after an isotopy, such a link L is invariant by the action \mathbb{G} and K_0 is contained in $\text{Fix}(\gamma_1)$. The following proposition provides a more precise description of such links.

Proposition 6.1. *Let $L = K_0 \cup \mathcal{O}_\mu$ be a link providing an admissible root. Assume that K_0 is contained in $S = \text{Fix}(\gamma_1)$. Then the following hold.*

- (1) Suppose no component of \mathcal{O}_μ is f -invariant. Then there is an f -invariant family of pairwise disjoint discs $\{D_i\}_{i=1}^\mu$ such that $\partial D_i = O_i$ and D_i intersects S transversely precisely in a single arc ($1 \leq i \leq \mu$).
- (2) Suppose one component, say O_1 , of \mathcal{O}_μ is f -invariant. Then there is an f -invariant family of discs $\{D'_1, D''_1\} \cup \{D_i\}_{i=2}^\mu$ with disjoint interiors, such that $\partial D'_1 = \partial D''_1 = O_1$, $\partial D_i = O_i$ ($2 \leq i \leq \mu$), and that each disc in the family intersects S transversely precisely in a single arc.

In particular, each component of \mathcal{O}_μ meets S transversally in two points, in both cases.

Proof. (1) Suppose no component of \mathcal{O}_μ is f -invariant. Then, since f is orientation-preserving and since \mathcal{O}_μ is a trivial link, the equivariant Dehn's lemma [18, Theorem 5] implies that there is an f -invariant family of mutually disjoint discs $\{D_i\}_{i=1}^\mu$ such that $\partial D_i = O_i$. To prove the proposition we will show that we can choose $\{D_i\}_{i=1}^\mu$ so that each D_i intersects $S := \text{Fix}(\gamma_1)$ precisely in one arc.

By small isotopy, we can assume that the family $\{D_i\}_{i=1}^\mu$ intersects the sphere S transversally: in the case where $O_i = \partial D_i$ is contained in S by “transversally along O_i ” we mean that there is a collar neighbourhood of ∂D_i in D_i that intersects S only along ∂D_i .

We want to show that one can eliminate all circle components of $S \cap (\cup_{i=1}^\mu \text{int} D_i)$. We start by observing that, for each such circle component C , there is a well-defined notion of the inside of C (in the sphere S). Indeed, for each C one can consider the circle $f(C)$. These are two disjoint circles in S , so they bound disjoint subdiscs of S , and the *inside* of C is defined to be the interior of the subdisc bounded by C that is disjoint from $f(C)$: observe that the notion of the inside is f -equivariant, i.e., the inside of $f(C)$ is the image of the inside of C by f . Remark now that a circle component of $S \cap (\cup_{i=1}^\mu \text{int} D_i)$ can be of two types: either it contains some arc component of $S \cap (\cup_{i=1}^\mu D_i)$ (*first type*) or it does not (*second type*).

We can eliminate all circles of the second type in an f -equivariant way, as follows. Note that a circle of this type can only contain circles of the same type in its inside. Let C be any such circle which is innermost in S so that $f(C)$ is also innermost in S . The circle C (respectively $f(C)$) is also contained in a disc D_i (respectively $f(D_i)$) of our family, where it bounds a subdisc. We now replace by surgery such subdisc in D_i (respectively $f(D_i)$) with a disc parallel to the subdisc of S contained in C (respectively $f(C)$) slightly off S , chosen appropriately on the side of S that allows to eliminate the intersection. Notice that this operation can be carried out even when C (respectively $f(C)$) contains points of K_0 and it may result in eliminating other circle intersections, since C (respectively $f(C)$) is not necessarily innermost in $\cup_{i=1}^\mu D_i$.

The above argument shows that we can assume that all circles in $S \cap (\cup_{i=1}^\mu \text{int} D_i)$ are of the first type, i.e., contain arc components of $S \cap (\cup_{i=1}^\mu D_i)$. Under this hypothesis, we now show how to eliminate all circles. Let now C be a circle

component of $S \cap (\cup_{i=1}^{\mu} \text{int} D_i)$ which is innermost in $\cup_{i=1}^{\mu} D_i$: $f(C)$ is also innermost in $\cup_{i=1}^{\mu} D_i$. Let Δ be the disc bounded by C in $\cup_{i=1}^{\mu} D_i$: it is entirely contained in one of the two balls bounded by S that we shall denote by B^+ . The disc $f(\Delta)$, bounded by $f(C)$ is contained in the second ball, denoted by B^- . Consider now $\gamma_1(\Delta) \subset B^-$ and $\gamma_1(f(\Delta)) = f(\gamma_1(\Delta)) \subset B^+$. Since \mathcal{O}_μ is γ_1 -invariant, the interiors of these discs are disjoint from \mathcal{O}_μ and also from L . Up to small isotopy, we can assume that the two discs meet the family $\cup_{i=1}^{\mu} D_i$ transversally. If the interior of $\gamma_1(\Delta)$ is disjoint from $\cup_{i=1}^{\mu} D_i$ (and so is the interior of $f(\gamma_1(\Delta))$), then we can use these two discs to remove the intersection C and $f(C)$. Otherwise, we perform f -equivariant surgery along the family $\cup_{i=1}^{\mu} D_i$ in order to eliminate all intersections in the interior of the two discs $\gamma_1(\Delta)$ and $f(\gamma_1(\Delta))$, as follows. Indeed, let C' be an innermost circle of intersection in $\gamma_1(\Delta)$. C' must be contained in and bound a subdisc of some disc D_i . One can now replace the subdisc of D_i with a copy of the disc bounded by C' in $\gamma_1(\Delta)$ to reduce the intersection. At the same time, one can replace the subdisc bounded by $f(C')$ in $f(D_i)$ with the subdisc bounded by $f(C')$ in $f(\gamma_1(\Delta))$: note that these operations take place in disjoint balls. We stress again that such surgery can only diminish the number of components of $S \cap (\cup_{i=1}^{\mu} \text{int} D_i)$ because C' and $f(C')$ are not necessarily innermost in $\cup_{i=1}^{\mu} D_i$.

We continue to denote by $\{D_i\}_{i=1}^{\mu}$ the family obtained after surgery. Let C be the circle chosen at the beginning of the preceding paragraph. If it is no longer contained in $\cup_{i=1}^{\mu} D_i$ then there is nothing to do; note that in this case the intersection $f(C)$ has also been removed. Suppose C is contained in $\cup_{i=1}^{\mu} D_i$. If the interior of $\gamma_1(\Delta)$ is not disjoint from $\cup_{i=1}^{\mu} D_i$, then we repeat the preceding argument to decrease the intersection. If the interior of $\gamma_1(\Delta)$ is disjoint from $\cup_{i=1}^{\mu} D_i$, then can use $\gamma_1(\Delta)$ and $f(\gamma_1(\Delta))$ to remove C and $f(C)$, as in the preceding paragraph.

The above shows that the family can be chosen so that $S \cap (\cup_{i=1}^{\mu} \text{int} D_i)$ does not contain circle components. This implies immediately that no component of \mathcal{O}_μ can be disjoint from the sphere S or contained in it for in this case the link L would be split, contrary to the assumption that it is hyperbolic: indeed if O_i is any such component, the interior of the disc D_i in the family just constructed is disjoint from \mathcal{O}_μ and S , and thus does not meet K_0 either. This completes the proof of the assertion (1) of the proposition.

(2) Suppose one component, say O_1 , of \mathcal{O}_μ is f -invariant. By Theorem 1.2(1), the other components of \mathcal{O}_μ are not f -invariant. Then by the equivariant Dehn's lemma, there is an f -invariant family of $\mu+1$ discs $\{D'_1, D''_1\} \cup \{D_i\}_{i=2}^{\mu}$ with disjoint interiors, such that $\partial D'_1 = \partial D''_1 = O_1$, $\partial D_i = O_i$ ($2 \leq i \leq \mu$). We can assume that this family intersects the sphere S transversally. For each loop component C of $\mathcal{I} := S \cap ((\text{int} D'_1 \cup \text{int} D''_1) \cup (\cup_{i=2}^{\mu} \text{int} D_i))$, we define its inside and its type as in the proof of (1). Note that each of $S \cap D'_1$ and $S \cap D''_1$ contains a unique arc component, denoted by α'_1 and α''_1 respectively, and the union $\alpha'_1 \cup \alpha''_1$ forms

a great circle in S . This implies that no loop component of \mathcal{I} contains α'_1 or α''_1 in its inside. (It should be also noted that the loop $\alpha'_1 \cup \alpha''_1$ is not contained in \mathcal{I} .) Now, the argument in the proof of (1) works verbatim, and we can remove all loop components of \mathcal{I} , completing the proof of (2) of the proposition. \square

Remark 6.2. In the above proposition, the link $L = K_0 \cup \mathcal{O}_\mu$ is recovered from the f -invariant arc system in S which is obtained as the intersection of the f -invariant family of disks with S . To explain this, identify \mathbf{S}^3 with the suspension of S , the space obtained from $S \times [-1, 1]$ by identifying the subspaces $S \times \{\pm 1\}$ to a point. We assume that the \mathbb{G} -action on \mathbf{S}^3 is equivalent to the \mathbb{G} -action on the suspension that is obtained from the natural product action of \mathbb{G} on $S \times [-1, 1]$. Then the following hold.

- (1) In the first case, set $\alpha_i = D_i \cap S$ ($1 \leq i \leq \mu$). Then L is \mathbb{G} -equivariantly homeomorphic to the link in the suspension obtained as the image of

$$K_0 \cup (\cup_{i=1}^\mu \partial(\alpha_i \times [-1/2, 1/2])) \subset S \times [-1, 1].$$

- (2) In the second case, set $\alpha'_1 = D'_1 \cap S$ and $\alpha_i = D_i \cap S$ ($2 \leq i \leq \mu$). Then L is \mathbb{G} -equivariantly homeomorphic to the link in the suspension obtained as the image of

$$K_0 \cup \partial(\alpha'_1 \times [-1, 1]) \cup (\cup_{i=2}^\mu \partial(\alpha_i \times [-1/2, 1/2])) \subset S \times [-1, 1].$$

It should be noted that the image of $\partial(\alpha'_1 \times [-1, 1])$ in the suspension of S is the suspension of $\partial\alpha'_1 = O_1 \cap S \subset S$. Moreover, if α_1 is any arc in S with endpoints $O_1 \cap S$ such that $\alpha_1 \cap f(\alpha_1) = \partial\alpha_1$, then L is ($\langle \gamma_1 \rangle$ -equivariantly, but not \mathbb{G} -equivariantly) homeomorphic to the link in the suspension obtained as the image of

$$K_0 \cup \partial(\alpha_1 \times [-2/3, 2/3]) \cup (\cup_{i=2}^\mu \partial(\alpha_i \times [-1/2, 1/2])) \subset S \times [-1, 1].$$

For example, the links L_6 and L_3 , respectively, satisfy the condition (1) and (2) of Proposition 6.1, and they are represented by the arcs systems (1) and (2) in Figure 6.

Next, we present the following generalisation of Remark 5.9(1).

Proposition 6.3. *Let K be an invertible amphicheiral knot having free period 2 and let $L = K_0 \cup \mathcal{O}_\mu$ be its root. Let γ_i and γ'_i respectively, $i = 1, 2$, be the symmetries of L generating the two \mathbb{G} -actions (compare Remark 1.3 and Subsection 3.2). Then any extension \hat{h} of the element $h = \gamma_1 \gamma'_1$ is never a strong inversion of K .*

Proof. Assume by contradiction that \hat{h} is a strong inversion of K extending h . Recall that according to Theorem 1.2, K_0 is a trivial knot contained in the 2-sphere $S = \text{Fix}(\gamma_1)$, moreover the 2-sphere $S' = \text{Fix}(\gamma'_1)$ intersects S perpendicularly and meets K_0 in two antipodal points. Consider now the sublink $\mathcal{O} = \mathcal{O}_\mu$ of L : according to Theorem 1.2 it must contain two components that intersect transversally S and two components that intersect transversally S' . We note that, under

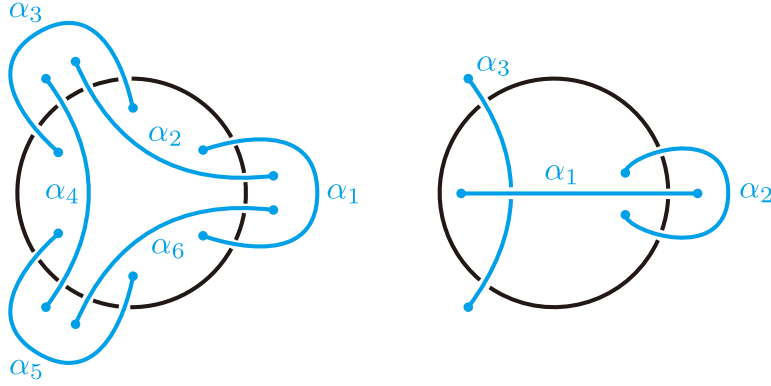
FIGURE 6. The arc systems for a L_6 and L_3 .

our hypotheses, a component that meets S (respectively S') transversally cannot intersect S' (respectively S) transversally. This follows from the fact that, by the consideration in Remark 5.9, h cannot leave a component invariant and act as a rotation on it, so that a component either intersects $\text{Fix}(h)$ or its linking number with $\text{Fix}(h) = S \cap S'$ must be even, and hence zero. This implies that \mathcal{O} contains (at least two) components that intersect S' transversally and are either contained in S or disjoint from it. This is however impossible according to Proposition 6.1. \square

Finally, we show that the first assertion of Theorem 1.2 (i.e., Claim 5.1) is “best possible”, in the sense that all situations described in the claim can arise.

Let $L = K_0 \cup \mathcal{O}_\mu$ be a link which provides an admissible root. We first assume that K_0 is the unique \mathbb{G} -invariant component of L . Then L satisfies one of the following conditions.

- (1) K_0 is a trivial knot contained in $\text{Fix}(\gamma_1)$.
- (2) K_0 is a trivial knot meeting $\text{Fix}(\gamma_1)$ in two points.
- (3) K_0 is a composite knot meeting $\text{Fix}(\gamma_1)$ in two points.

The links L_6 and L_2 in Section 3 provide examples of the first and the third situations, respectively. We show that the second situation can also occur. Consider the configuration of Figure 7, where each small box represents a rational tangle such that (i) the strands of the tangles behave combinatorially as the dotted arcs inside the boxes, and (ii) the tangles are not a sequence of twists.

For each choice of rational tangles as above, the result is a link with three trivial components (note that when forgetting the outer- respectively inner-component, the inner- respectively outer-component and the central one form a Montesinos link). The exterior of the the four central small boxes and of the dotted ones is a *basic polyhedron* (see [15, ch. 10]), so it is π -hyperbolic by Andreev’s theorem. The interiors of the dotted boxes have Seifert fibred double covers, regardless of the chosen rational tangles. It follows that, for sufficiently large rational tangles inserted

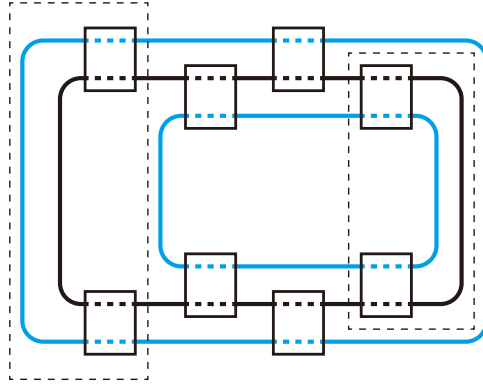

FIGURE 7. A link providing an admissible root with a single trivial \mathbb{G} -invariant component containing $Fix(\gamma_2)$, which forms a trivial knot.

into the four central small boxes, the exterior of the dotted boxes is π -hyperbolic. It follows that, for sufficiently large rational tangles, the Bonahon-Siebenmann decomposition [4] of the orbifold associated to the link with branching order 2 consists of three geometric pieces: two Seifert fibred ones, and a π -hyperbolic one which is their complement. Since the Seifert fibred ones are atoroidal (and the π -hyperbolic one is anannular), the link is hyperbolic. It is now easy to see that the construction can be carried out in a \mathbb{G} -equivariant way so that the black central component is \mathbb{G} -invariant, providing an admissible root with the desired property.

We next consider the case where L has two \mathbb{G} -invariant components. Then these can be both trivial, as is the case of L_3 , or one trivial and one composite. An example of the latter type can be built from the same tangle in the half ball used to construct L_2 but with a different gluing and an extra component contained in $Fix(\gamma_1)$, see Figure 8. Hyperbolicity of this link can be checked using a computer program like SnapPea, SnapPy, or HIKMOT, or can be proved following the same lines as the proof provided for L_2 (see Section 7) by a slight adaptation of Lemma 7.4, since K_D is in a different position: details are left to the interested reader.

These two observations say that the first assertion of Theorem 1.2 (i.e., Claim 5.1) is “best possible”.

7. THE LINK L_2 IS HYPERBOLIC

Consider the link $L_2 = K_0 \cup \mathcal{O}_2$ with $\mathcal{O}_2 = \mathcal{O}_1 \cup \mathcal{O}_2$ in Figure 1(3). Then L_2 is the double of the tangle $(\mathbf{B}^3, \tau) := (\mathbf{B}^3, \tau_0 \cup \tau_1 \cup \tau_2)$ in Figure 1(2). The tangle (\mathbf{B}^3, τ) is regarded as the sum of the tangle $(\mathbf{B}^3, t) := (\mathbf{B}^3, t_0 \cup t_1 \cup t_2)$ in Figure 1(1) with its mirror image.

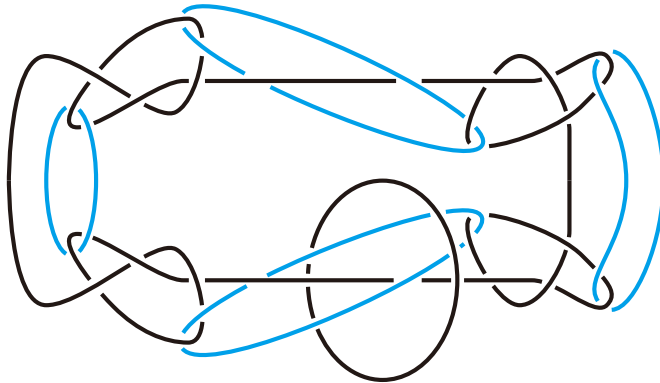

FIGURE 8. A link providing an admissible root with two \mathbb{G} -invariant components consisting of a trivial knot and a composite one.

Lemma 7.1. *The tangle $(\mathbf{B}^3, t_0 \cup t_1)$ obtained by removing one of the unknotted arcs, as in Figure 9, is hyperbolic with totally geodesic boundary. To be precise, $B^3 \setminus (t_0 \cup t_1)$ admits a complete hyperbolic structure, such that $\partial(B^3 \setminus (t_0 \cup t_1))$ is a totally geodesic surface.*

Proof. If we take the double of the tangle, we obtain the pretzel link $P(3, 2, -2, -3)$, which is hyperbolic by [5] (see also [3, 11]). The desired result follows from this fact. \square

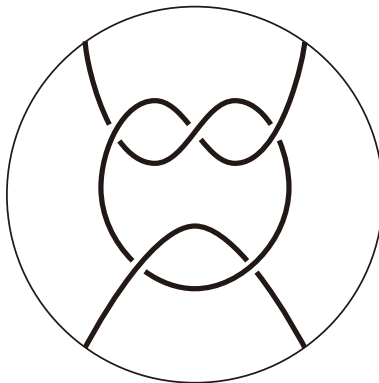

FIGURE 9. The tangle $(\mathbf{B}^3, t_0 \cup t_1)$.

Lemma 7.2. *The link, L' , obtained as the double of $(\mathbf{B}^3, t_0 \cup t_1 \cup t_2)$, is prime and unsplittable.*

Proof. Observe that the link L' is obtained from the link $L'' := P(3, 2, -2, -3)$ by adding a parallel copy of the unknotted component. Thus the exterior $E(L')$

is obtained from the hyperbolic manifold $E(L'')$ and the Seifert fibered space $P \times \mathbf{S}^1$ with P a two-holed disc, by gluing along two incompressible toral boundary components. Since both $E(L'')$ and $P \times \mathbf{S}^1$ are irreducible and since the torus $\partial P \times \mathbf{S}^1$ is incompressible both in $E(L'')$ and $P \times \mathbf{S}^1$, we see that $E(L')$ is irreducible. Hence L' is unsplittable. Since $E(L'')$ admits no essential annuli, we see that the only essential annuli in $E(L')$ are saturated annuli contained in $P \times \mathbf{S}^1$ with boundary components contained in $\partial(P \times \mathbf{S}^1) \setminus \partial E(L'')$. Hence L' is prime. \square

Lemma 7.3. (1) *Let Δ be a disc properly embedded in \mathbf{B}^3 such that Δ is disjoint from t . Then Δ cuts off a 3-ball in \mathbf{B}^3 disjoint from t .*

(2) *Let Δ be a disc properly embedded in \mathbf{B}^3 such that Δ intersects t transversely in a single point. Then Δ cuts off a 3-ball, B , in \mathbf{B}^3 such that $(B, t \cap B)$ is a 1-string trivial tangle.*

Proof. Suppose that there exists a disc, Δ , properly embedded in \mathbf{B}^3 such that either Δ is disjoint from t or Δ intersects t transversely in a single point, and which does not satisfy the desired conditions. Then the double of Δ gives a 2-sphere in \mathbf{S}^3 which separates the components of L' or gives a nontrivial decomposition of L' . This contradicts Lemma 7.2. \square

Let D be the flat disc forming the right side of $\partial \mathbf{B}^3$ as illustrated in Figure 1(1), and set $K_D = \partial D$.

Lemma 7.4. *There does not exist an essential annulus, A , in $\mathbf{B}^3 \setminus t$ whose boundary is disjoint from K_D . To be precise, any incompressible annulus A properly embedded in $\mathbf{B}^3 \setminus t$ such that $\partial A \cap K_D = \emptyset$ is parallel in $\mathbf{B}^3 \setminus t$ to (i) an annulus in $\partial \mathbf{B}^3 \setminus (K_D \cup t)$, (ii) the frontier of a regular neighbourhood of K_D or (iii) the frontier of a regular neighbourhood of a component t_i of t .*

Proof. Suppose to the contrary that there is an essential annulus, A , in $\mathbf{B}^3 \setminus t$ such that $\partial A \cap K_D = \emptyset$. Since A is compressible in \mathbf{B}^3 , it bounds a cylinder $B^2 \times I$ with $I = [0, 1]$, where $A = \partial B^2 \times I$ and $B^2 \times \partial I \subset \partial \mathbf{B}^3$.

Case 1. One component of ∂A is contained in $\text{int} D$ and the other component is contained in $D^c := \partial \mathbf{B}^3 \setminus D$. Then we may assume $B^2 \times 0 \subset \text{int} D$ and $B^2 \times 1 \subset D^c$. If A is compressible in $\mathbf{B}^3 \setminus (t_0 \cup t_1)$, then the cylinder must contain t_2 . Since t_2 has an endpoint in $\text{int} D$ and the other endpoint in D^c , t_2 has an endpoint in $B^2 \times 0$ and the other endpoint in $B^2 \times 1$. Since t_2 is unknotted, this implies t_2 forms the core of the cylinder and hence A is parallel to the frontier of a regular neighbourhood of t_2 . This contradicts the assumption that A is essential in $\mathbf{B}^3 \setminus t$. So, we may assume A is incompressible in $\mathbf{B}^3 \setminus (t_0 \cup t_1)$. Thus Lemma 7.1 implies that A is parallel in $\mathbf{B}^3 \setminus (t_0 \cup t_1)$ to (i) the frontier of a regular neighbourhood of t_0 , (ii) the frontier of a regular neighbourhood of t_1 or (iii) an annulus in $\partial \mathbf{B}^3 \setminus (t_0 \cup t_1)$.

Subcase 1-i. A is parallel in $\mathbf{B}^3 \setminus (t_0 \cup t_1)$ to the frontier of a regular neighbourhood $N(t_0)$ of t_0 . Since t_0 is knotted whereas t_1 and t_2 are unknotted and since each t_i has an endpoint in $\text{int} D$ and the other endpoint in D^c , we see that

t_1 and t_2 are not contained in $N(t_0)$. Hence A is parallel in $\mathbf{B}^3 \setminus t$ to the frontier of $N(t_0)$, a contradiction to the assumption that A is essential.

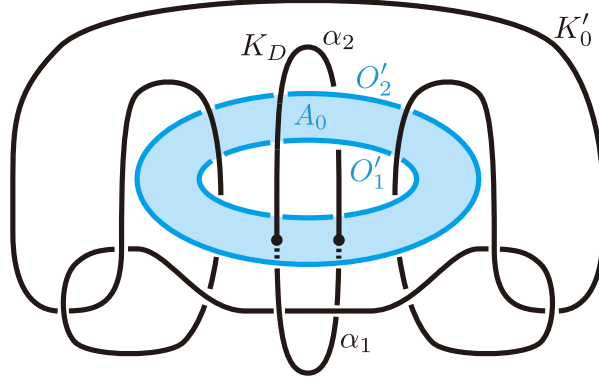

FIGURE 10. The link $L' \cup K_D = (K'_0 \cup O'_1 \cup O'_2) \cup K_D$ obtained as the “double” of $(\mathbf{B}^3, t \cup K_D)$, where the components K'_0 , O'_1 and O'_2 are the doubles of t_0 , t_1 and t_2 , respectively, and the component K_D is a copy of the loop $K_D \subset \partial\mathbf{B}^3$. The component K_D intersects the annulus A_0 bounded by O'_1 and O'_2 transversely in two points, which divides K_D into the two arcs α_1 and α_2 .

Subcase 1-ii. A is parallel in $\mathbf{B}^3 \setminus (t_0 \cup t_1)$ to the frontier of a regular neighbourhood $N(t_1)$ of t_1 in $\mathbf{B}^3 \setminus t_0$. If t_2 is not contained in $N(t_1)$, then A is parallel in $\mathbf{B}^3 \setminus t$ to the frontier of $N(t_1)$. So t_2 must be contained in $N(t_1)$. Now, let $L' \cup K_D$ be the link in \mathbf{S}^3 obtained as the “double” of $(\mathbf{B}^3, t \cup K_D)$, and let T be the torus in the exterior $E(L' \cup K_D)$ obtained as the double of the annulus A . Then, by the above observation, T bounds a solid torus, V , in \mathbf{S}^3 , such that $V \cap (L' \cup K_D) = O'_1 \cup O'_2$, where O'_i is the double of t_i ($i = 1, 2$). By the proof of Lemma 7.2, we know that the JSJ decomposition of $E(L')$ is given by the torus $T_0 := \partial E(L'') = \partial(P \times \mathbf{S}^1)$, and hence T is isotopic to T_0 in $E(L')$. Thus there is a self-diffeomorphism ψ of (\mathbf{S}^3, L') pairwise isotopic to the identity, which carries T_0 to T . Let A_0 be the annulus with $\partial A_0 = O'_1 \cup O'_2$ as illustrated in Figure 10. Note that, up to isotopy, T_0 is the boundary of a regular neighbourhood of A_0 . Note that the component K_D intersects A_0 transversely in two points, whereas K_D is disjoint from $\psi(T_0) = T \subset E(L' \cup K_D)$ and therefore K_D is disjoint from $\psi(A_0)$. Since ψ is pairwise isotopic to the identity, there is a smooth isotopy $\Psi : K_D \times [0, 1] \rightarrow E(L')$ such that $\Psi|_{K_D \times 0} = 1_{K_D}$ and $\Psi(K_D \times 1) = \psi^{-1}(K_D)$. We may assume Ψ is transversal to A_0 and so $F^{-1}(A_0)$ is a 1-dimensional submanifold of $K_D \times [0, 1]$. Since $K_D \cap A_0$ consists of two transversal intersection points and since $\psi^{-1}(K_D) \cap A_0 = \emptyset$, the 1-manifold $\Psi^{-1}(A_0)$ contains precisely one arc component, β , and it joins the two points $(K_D \cap A_0) \times 0$. Consider the disc, δ , in $K_D \times [0, 1]$ cut off by the arc β . Since $A_0 \cap E(L')$ is incompressible

in $E(L')$ and since $E(L')$ is irreducible, we may assume that the interior of δ is disjoint from $\Psi^{-1}(A_0)$. Thus the loop $\Psi(\partial\delta)$ is null-homotopic in $E(L')$. On the other hand, the loop $\Psi(\partial\delta)$ is the union of one of the two subarcs α_1 and α_2 of K_D bounded by $K_D \cap A_0 = \partial\beta$ (see Figure 10) and the path $\Psi(\beta)$ in A_0 joining the two points $K_D \cap A_0$. However, we can easily observe that $\text{lk}(\alpha_1 \cup \beta', K'_0) = \pm 1$ and $\text{lk}(\alpha_2 \cup \beta', O'_2) = \pm 1$ for any path β' in A_0 with endpoints $K_D \cap A_0$. This is a contradiction.

Subcase 1-iii. A is parallel in $\mathbf{B}^3 \setminus (t_0 \cup t_1)$ to an annulus, A' , in $\partial\mathbf{B}^3 \setminus (t_0 \cup t_1)$. Then A cuts off a solid torus, W , from $\mathbf{B}^3 \setminus (t_0 \cup t_1)$. Since A is essential, W must contain the component t_2 . This implies that O'_2 is null homotopic in $\mathbf{S}^3 \setminus K'_0$, where K'_0 is the double of t_0 . However, we can easily check by studying the knot group of the square knot K'_0 , that this is not the case.

Case 2. Both components of ∂A are contained in $\text{int}D$. Since each component of t_i has one endpoint in $\text{int}D$ and the other endpoint in D^c , we see that the components of ∂A are concentric in D , and that $B^2 \times 0$ is contained in $\text{int}D$ and that $B^2 \times 1$ contains D^c in its interior. Since t_1 joins $\text{int}D$ with D^c , t_1 joins $B^2 \times 0$ with $B^2 \times 1$ in the cylinder $B^2 \times I$. So the cylinder $B^2 \times I$ is unknotted in \mathbf{B}^3 and hence the closure of its complement in \mathbf{B}^3 is a solid torus, W . Since $\partial B^2 \times 0$ is a meridian of the solid torus $(\mathbf{S}^3 \setminus \text{int}\mathbf{B}^3) \cup B^2 \times I$, we see that $\partial B^2 \times 0$ is a longitude of W . So A is parallel to the annulus $A' := V \cap \partial\mathbf{B}^3$ through W . Since every component of t joins $\text{int}D$ with D^c , t must be contained in the cylinder and hence W is disjoint from t . This contradicts the assumption that A is essential. \square

Lemma 7.5. *The complement $\mathbf{B}^3 \setminus t$ does not contain an incompressible torus.*

Proof. This follows from the easily observed fact that the exterior $E(t)$ is homeomorphic to a genus 3 handlebody. Indeed, the exterior of t in \mathbf{B}^3 is the trefoil knot exterior with two parallel unknotting tunnels drilled out. \square

Lemma 7.6. *The tangle (\mathbf{B}^3, τ) is simple in the following sense.*

- (1) *Let Δ be a disc properly embedded in \mathbf{B}^3 such that Δ is disjoint from τ . Then Δ cuts off a 3-ball in \mathbf{B}^3 disjoint from τ .*
- (2) *Let Δ be a disc properly embedded in \mathbf{B}^3 such that Δ intersects τ transversely in a single point. Then Δ cuts off a 3-ball, B , in \mathbf{B}^3 such that $(B, \tau \cap B)$ is a 1-string trivial tangle.*
- (3) *There does not exist an essential annulus, A , in $\mathbf{B}^3 \setminus \tau$. To be precise, any incompressible annulus A properly embedded in $\mathbf{B}^3 \setminus \tau$ is parallel in $\mathbf{B}^3 \setminus \tau$ to (i) an annulus in $\partial\mathbf{B}^3 \setminus \tau$, (ii) the frontier of a regular neighbourhood of a component τ_i of τ .*
- (4) *$\mathbf{B}^3 \setminus \tau$ does not contain an incompressible torus.*

Proof. Note that (\mathbf{B}^3, τ) is obtained from (\mathbf{B}^3, t) and its mirror image by identifying D with its copy in the mirror image. Thus the assertion follows from

Lemmas 7.2-7.5 by using the standard cut and paste method (see [24, Criterion 6.1]). \square

Since (\mathbf{S}^3, L_2) is the double of the simple tangle (\mathbf{B}^3, τ) , we see that $\mathbf{S}^3 \setminus L_2$ is atoroidal, i.e., it does not contain an essential torus. Moreover, $\mathbf{S}^3 \setminus L_2$ is not a Seifert fibred space. This can be seen as follows. If it were a Seifert fibred space, then it should be a 2-fold composing space, i.e., homeomorphic to the complement of the connected sum of two Hopf links. Now we use the fact that for a given link L , the greatest common divisor, $d(L)$, of the linking numbers of the components is an invariant of the link complement. Since $d(\text{the connected sum of two Hopf links}) = 1$ and $d(L_2) = 0$, $\mathbf{S}^3 \setminus L_2$ cannot be a Seifert fibred space. Hence, by Thurston's uniformization theorem for Haken manifolds, $\mathbf{S}^3 \setminus L_2$ admits a complete hyperbolic structure, i.e., L_2 is hyperbolic.

8. THE LINK L_3 IS HYPERBOLIC

In this section, we prove that the link L_3 is hyperbolic. We begin with the following lemma.

Lemma 8.1. *There does not exist a 2-sphere, S , in \mathbf{S}^3 satisfying the following conditions.*

- (1) S is disjoint from K_0 .
- (2) Either S is disjoint from O_1 or S intersects O_1 transversely in two points.
- (3) S separates O_2 from O_3 , i.e., O_2 and O_3 are contained in distinct components of $\mathbf{S}^3 \setminus S$.

Proof. Suppose to the contrary that there is a 2-sphere S satisfying the conditions. Let $\tilde{\mathbf{S}}^3$ be the $\mathbb{Z}/2\mathbb{Z} \oplus \mathbb{Z}/2\mathbb{Z}$ -covering of \mathbf{S}^3 branched over the Hopf link $K_0 \cup O_1$, and let \tilde{S} and \tilde{O}_i , respectively, be the inverse image of S and O_i in $\tilde{\mathbf{S}}^3$. Then $\tilde{O}_2 \cup \tilde{O}_3$ is the link in the 3-sphere $\tilde{\mathbf{S}}^3$ as illustrated in Figure 11. Observe that any component of \tilde{O}_2 and any component of \tilde{O}_3 form a Hopf link. On the other hand, the inverse image of S in $\tilde{\mathbf{S}}^3$ consists of four or two mutually disjoint 2-spheres, each of which separates a component of \tilde{O}_2 from each component of \tilde{O}_3 . This is a contradiction. \square

Let \mathbf{B}^3 be one of the 3-balls in \mathbf{S}^3 bounded by \mathbf{S}^2 , and set $t_i := O_i \cap \mathbf{B}^3$ ($i = 1, 2, 3$). Then the pair (\mathbf{B}^3, t) with $t = t_1 \cup t_2 \cup t_3$ is a 3-string tangle, and K_0 is a loop in $\partial\mathbf{B}^3$. Let D and D' be the 2-discs in $\partial\mathbf{B}^3$ bounded by K_0 which contains ∂t_2 and ∂t_3 , respectively.

Lemma 8.2. *The three-punctured disc $D \setminus t$ is incompressible in $\mathbf{B}^3 \setminus t$. Namely, there does not exist a disc, Δ , properly embedded in \mathbf{B}^3 satisfying the following conditions.*

- (1) $\partial\Delta$ is a loop in $\text{int}(D \setminus t)$ which does not bound a disc in $\text{int}(D \setminus t)$.
- (2) Δ is disjoint from t .

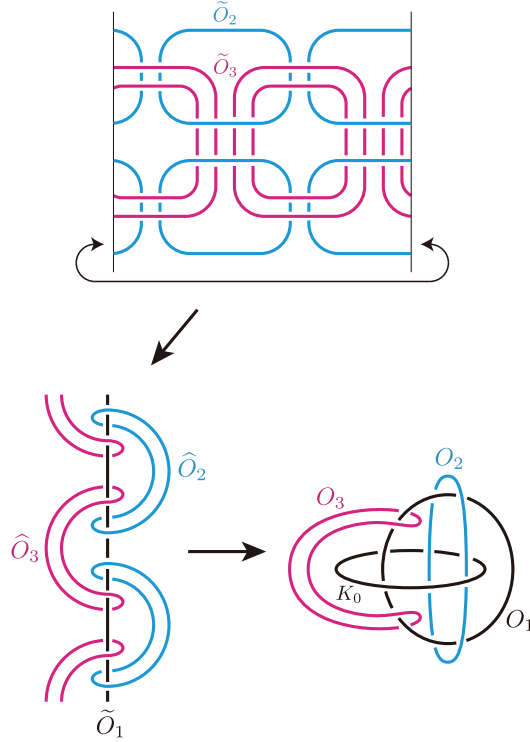

FIGURE 11. The bottom left drawing illustrates the double cover, $M_2(K_0)$, of \mathbf{S}^3 branched along K_0 and the inverse images of $\mathcal{O}_3 = O_1 \cup O_2 \cup O_3$. The $\mathbb{Z}/2\mathbb{Z} \times \mathbb{Z}/2\mathbb{Z}$ -cover, $M_{2\oplus 2}(K_0 \cup O_1)$, of \mathbf{S}^3 branched along the Hopf link $K_0 \cup O_1$ is obtained as the double cover of $M_2(K_0)$ branched along the inverse image of O_1 . The drawing on the top illustrates the inverse image of $O_2 \cup O_3$ in $M_{2\oplus 2}(K_0 \cup O_1)$, where the left and right sides are glued together.

Proof. Suppose to the contrary that there exists a disc Δ satisfying the conditions. Let D_Δ be the disc in D bounded by $\partial\Delta$, and let B be the 3-ball in \mathbf{B}^3 bounded by the 2-sphere $\Delta \cup D_\Delta$. Since each of t_1 and t_3 has an endpoint in $\text{int}D' \subset \partial\mathbf{B}^3 \setminus D_\Delta$ and since it is disjoint from Δ , both t_1 and t_3 are contained in the complement of B . So, by the second condition, t_2 has an endpoint in $\text{int}D_\Delta$, and therefore t_2 is contained in B . Hence, by taking the double of Δ , we obtain a 2-sphere in \mathbf{S}^3 satisfying the conditions in Lemma 8.1, which is a contradiction. \square

Lemma 8.3. *There does not exist a disc, Δ , properly embedded in \mathbf{B}^3 satisfying the following conditions.*

- (1) $\partial\Delta$ is a loop in $\text{int}(D \setminus t)$.
- (2) Δ intersects t transversely in a single point.
- (3) Δ does not cut off a 1-string trivial tangle from (\mathbf{B}^3, t) .

Proof. Suppose to the contrary that there exists a disc Δ satisfying the conditions. As in the proof of Lemma 8.2, let D_Δ be the disc in D bounded by $\partial\Delta$, and let B be the 3-ball in \mathbf{B}^3 bounded by $\Delta \cup D_\Delta$. Since the endpoints of t_3 are contained in $\text{int}D' \subset \partial\mathbf{B}^3 \setminus D_\Delta$ and since t_3 intersects Δ in at most one point, we see that t_3 is contained in the complement of B . So, precisely one of t_1 or t_2 intersects Δ . Suppose that Δ intersects t_1 . Then, since t_1 is an unknotted arc, the third condition implies that the 3-ball B must contain t_2 . Hence, by taking the double of Δ , we obtain a 2-sphere in \mathbf{S}^3 satisfying the conditions in Lemma 8.1, which is a contradiction. Hence t_1 is disjoint from Δ and t_2 intersect Δ transversely in a single point. Since both t_1 and t_3 are disjoint from B and since t_2 is an unknotted arc, we see that $(B, t \cap B) = (B, t_2 \cap B)$ is a trivial 1-string tangle. This contradicts the assumption that Δ satisfies the third condition. \square

Let δ_2 and δ_3 be the discs in \mathbf{B}^3 as illustrated in Figure 12.

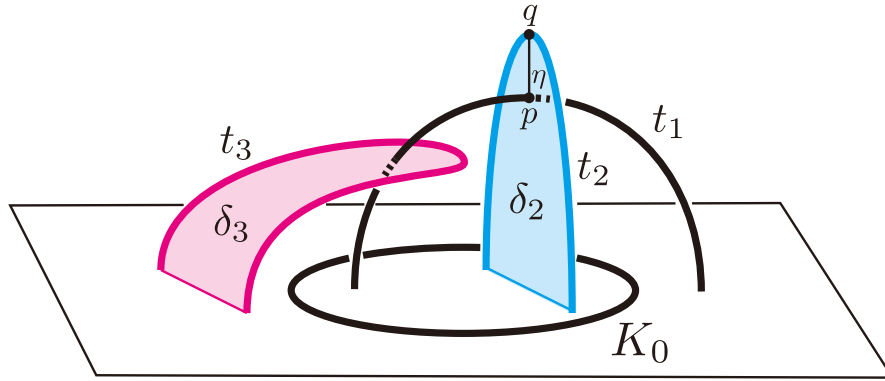

FIGURE 12. The discs δ_2 and δ_3 and the arc η .

Lemma 8.4. *There does not exist a disc, Δ , in \mathbf{B}^3 satisfying the following conditions.*

- (1) $\partial\Delta = \alpha \cup \beta$, where α is an arc properly embedded in $\delta_2 \setminus t$ and β is an arc in $\text{int}(D \setminus t)$ such that $\beta \cap \delta_2 = \partial\beta = \partial\alpha$.
- (2) Δ is disjoint from t .
- (3) The disc Δ is nontrivial in the following sense. Let $\delta_{2,\Delta}$ be the subdisc of δ_2 bounded by $\alpha \cup \alpha'$, where α' is the subarc of $\delta_2 \cap D$ bounded by $\partial\alpha$. Then the disc $\Delta \cup \delta_{2,\Delta}$ does not cut off a 3-ball in \mathbf{B}^3 which is disjoint from t .

Proof. Suppose to the contrary that there exists a disc Δ satisfying the conditions. Let D_Δ be the subdisc of D bounded by $\alpha' \cup \beta$. Since Δ is disjoint from t , the loop $\partial\delta_{2,\Delta}$ is homotopic to the loop ∂D_Δ in $\mathbf{B}^3 \setminus t$. Thus $\delta_{2,\Delta}$ contains the point $t_1 \cap \delta_2$ if and only if D_Δ contains the point $t_1 \cap D$.

Suppose first that D_Δ does not contain the point $t_1 \cap D$ and so $\delta_{2,\Delta}$ does not contain the point $t_1 \cap \delta_2$. Then $\Delta \cup \delta_{2,\Delta}$ is a disc properly embedded in \mathbf{B}^3 disjoint

from t . Hence the disc D_Δ in D bounded by $\partial(\Delta \cup \delta_{2,\Delta})$ is disjoint from t by Lemma 8.2. Since (\mathbf{B}^3, t) is a 3-strand trivial tangle, $\mathbf{B}^3 \setminus t$ is homeomorphic to a genus 3 handlebody (with three annuli on the boundary removed), and so $\mathbf{B}^3 \setminus t$ is irreducible. Hence the 2-sphere $\Delta \cup \delta_{2,\Delta} \cup D_\Delta$ bounds a 3-ball in $\mathbf{B}^3 \setminus t$. This contradicts the assumption that Δ satisfies the third condition that Δ is nontrivial.

Suppose next that D_Δ contains the point $t_1 \cap D$ and so $\delta_{2,\Delta}$ contains the point $t_1 \cap \delta_2$. Consider an arc in the disc $\delta_{2,\Delta} \cup D_\Delta$ joining the two points $t_1 \cap (\delta_{2,\Delta} \cup D_\Delta)$, and let γ be the boundary of its regular neighbourhood in $\delta_{2,\Delta} \cup D_\Delta$. Then $\partial\Delta = \partial(\delta_{2,\Delta} \cup D_\Delta)$ is homotopic to γ in $\mathbf{B}^3 \setminus t$. Note that γ is as illustrated in Figure 13. If we ignore the string t_2 and regard γ as a loop in $\mathbf{B}^3 \setminus (t_1 \cup t_3)$, then the free homotopy class of γ up to orientation corresponds to the conjugacy class of the free group $\pi_1(\mathbf{B}^3 \setminus (t_1 \cup t_3))$ represented by $x_1(x_3x_1^{-1}x_3^{-1})$, where $\{x_1, x_3\}$ is the free basis illustrated in Figure 13. This contradicts the fact that Δ is disjoint from t . This completes the proof of Lemma 8.4. \square

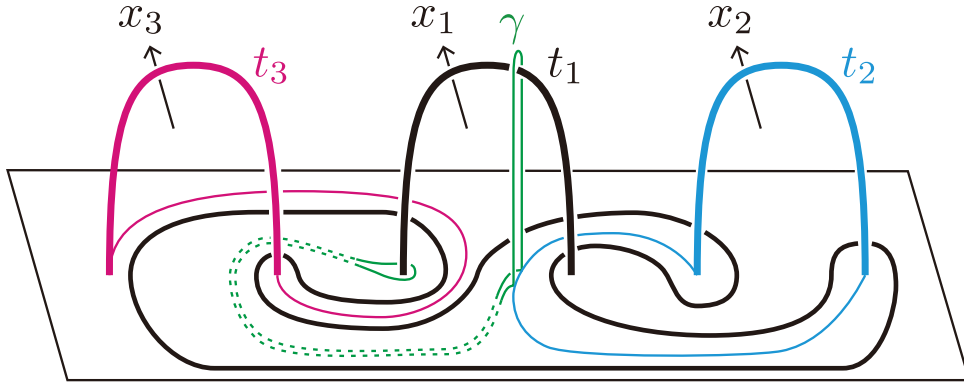

FIGURE 13. The loop γ in green and the free basis of the fundamental group of the handlebody.

Remark 8.5. The restriction of the antipodal map γ_2 to \mathbf{B}^3 gives a diffeomorphism of $(\mathbf{B}^3, K_0 \cup t)$ interchanging D with D' (and δ_2 with δ_3). Hence, we may replace D with D' (and δ_2 with δ_3) in Lemmas 8.2, 8.3 and 8.4.

Lemma 8.6. *There does not exist an essential annulus, A , in $\mathbf{B}^3 \setminus t$ whose boundary is disjoint from $K_0 = \partial D = \partial D'$. To be precise, any incompressible annulus A properly embedded in $\mathbf{B}^3 \setminus t$ such that $\partial A \cap K_0 = \emptyset$ is parallel in $\mathbf{B}^3 \setminus t$ to (i) an annulus in $\partial\mathbf{B}^3 \setminus (K_0 \cup t)$, (ii) the frontier of a regular neighbourhood of K_0 or (iii) the frontier of a regular neighbourhood of a component t_i of t .*

Proof. Suppose to the contrary that there is an essential annulus, A , in $\mathbf{B}^3 \setminus t$ such that $\partial A \cap K_0 = \emptyset$. Since A is compressible in \mathbf{B}^3 , it bounds a cylinder $B^2 \times I$ with $I = [0, 1]$, where $A = \partial B^2 \times I$ and $B^2 \times \partial I \subset \partial\mathbf{B}^3$.

Case 1. One component of ∂A is contained in $\text{int}D$ and the other component is contained in $\text{int}D'$. Then we may assume $B^2 \times 0 \subset \text{int}D$ and $B^2 \times 1 \subset D'$. Since A is incompressible, $B^2 \times 1$ must contain at least one point of ∂t . If $B^2 \times 1$ contains exactly one point of ∂t , then pushing $A \cup (B^2 \times 1)$ into the interior of \mathbf{B}^3 , we obtain a properly embedded disc Δ in \mathbf{B}^3 which satisfies the first two conditions of Lemma 8.3. The lemma implies that Δ cuts off a 1-string trivial tangle and so A is parallel to the frontier of the boundary of a regular neighbourhood of a component of t , a contradiction. So, $B^2 \times 1$ contains at least two points of ∂t . By Remark 8.5, the same argument also implies that $B^2 \times 0$, as well, contains at least two points of ∂t . Suppose that $B^2 \times 1$ contains the three points $D' \cap \partial t = D' \cap \partial(t_1 \cup t_3)$. Then the cylinder $B^2 \times I$ contains $t_1 \cup t_3$, because A is disjoint from t . Since $B^2 \times 0$ contains at least two points of ∂t , it must contain a point of ∂t_2 . Hence we see that the cylinder $B^2 \times I$ contains the whole $t = t_1 \cup t_2 \cup t_3$. Since the arc t_1 , which joins a point of $B^2 \times 0$ and a point of $B^2 \times 1$ in the cylinder $B^2 \times I$, is unknotted, the cylinder is unknotted in \mathbf{B}^3 and hence the closure of its complement is a solid torus. This implies that A is parallel to the frontier of a regular neighbourhood of K_0 in \mathbf{B}^3 , a contradiction. Hence both $B^2 \times 0$ and $B^2 \times 1$ contain exactly two points of ∂t . Thus we see that $t_2 \cup t_3$ is contained in the cylinder $B^2 \times I$ and that t_1 is contained in the complement of the cylinder.

Claim 8.7. *We may assume that A is disjoint from the discs δ_2 and δ_3 .*

Proof. We may assume that the intersection of A with $\delta_2 \cup \delta_3$ is transversal and the number of components of $A \cap (\delta_2 \cup \delta_3)$ is minimised. Suppose that $A \cap (\delta_2 \cup \delta_3)$ contains loop components. Pick a loop component, C , which is innermost in $\delta_2 \cup \delta_3$, and let δ_C be the subdisc of $\delta_2 \cup \delta_3$ bounded by C . Suppose δ_C contains a point of $t \cap (\delta_2 \cup \delta_3) = t_1 \cap (\delta_2 \cup \delta_3)$. Then C forms a meridian of t_1 and hence it is not null-homotopic in $\mathbf{B}^3 \setminus t$. So C cannot be null-homotopic in the annulus $A \subset \mathbf{B}^3 \setminus t$ and so C forms a core loop A . However, since t_1 is contained in the complement of the cylinder $B^2 \times I$, the disc in the cylinder bounded by C is disjoint from t_1 , and therefore C is null-homotopic in $\mathbf{B}^3 \setminus t_1$, a contradiction. Hence δ_C is disjoint from t . Since A is incompressible, C bounds a disc, A_C , in A . The union $A_C \cup \delta_C$ is a 2-sphere in the irreducible manifold $\mathbf{B}^3 \setminus t$. Thus we can remove the intersection C by using the 3-ball bounded by $A_C \cup \delta_C$. This contradicts the minimality of the intersection $A \cap (\delta_2 \cup \delta_3)$. Thus we have shown that $A \cap (\delta_2 \cup \delta_3)$ has no loop components, and so it is either empty or consists of arcs whose boundaries are contained in $\partial \mathbf{B}^3 \cap (\delta_2 \cup \delta_3)$.

Suppose that $A \cap (\delta_2 \cup \delta_3)$ is nonempty, and pick an arc component, C , which is “outermost” in $\delta_2 \cup \delta_3$. Let δ_C be the “outermost” subdisc of $\delta_2 \cup \delta_3$ bounded by C and the subarc of $\partial \mathbf{B}^3 \cap (\delta_2 \cup \delta_3)$ bounded by ∂C . Since ∂C lies either in D or D' , the arc C must be inessential in A and it cuts off a disc, A_C , from A . If $\partial C \subset D$, then the union $\Delta := A_C \cup \delta_C$ satisfies the first two conditions of Lemma 8.4. Hence the lemma implies that Δ is “trivial” and so we can remove the intersection C .

This contradicts the minimality of the intersection $A \cap (\delta_2 \cup \delta_3)$. By Remark 8.5, the same argument works when $\partial C \subset D'$. Thus we obtain the claim. \square

By the above claim, $\partial B^2 \times 0$ is isotopic in $\mathbf{B}^3 \setminus t$ to the boundary of a regular neighbourhood of $\delta_2 \cap D$ in $D \setminus t_1$, and $\partial B^2 \times 1$ is isotopic in $\mathbf{B}^3 \setminus t$ to the boundary of a regular neighbourhood of $\delta_3 \cap D'$ in $D' \setminus t_1$. Hence, the loop $\partial B^2 \times 0$ is null-homotopic in $\mathbf{B}^3 \setminus (t_1 \cup t_3)$, and the loop $\partial B^2 \times 1$ represents the conjugacy class of the nontrivial element $((x_1 x_3 x_1^{-1}) x_3^{-1})^{\pm 1}$ in $\pi_1(\mathbf{B}^3 \setminus (t_1 \cup t_3))$ (see Figure 13). This contradicts the fact that these loops are freely homotopic in $\mathbf{B}^3 \setminus t$ and hence in $\mathbf{B}^3 \setminus (t_1 \cup t_3)$. So, we have shown that Case 1 cannot happen.

Case 2. Both components of ∂A are contained in $\text{int}D$, and they bound mutually disjoint discs in $\text{int}D$. Then we have $B^2 \times \partial I \subset \text{int}D$. By the argument in the first step in Case 1 by using the incompressibility of A and Lemma 8.3, we can see that both $B^2 \times 0$ and $B^2 \times 1$ contain at least two points of ∂t . Then D must contain at least four points of ∂t , a contradiction. By Remark 8.5, the same argument works when both components of ∂A are contained in $\text{int}D'$, and they bound mutually disjoint discs in $\text{int}D'$.

Case 3. Both components of ∂A are contained in $\text{int}D$, and they are concentric in $\text{int}D$. Then we may assume that $B^2 \times 0$ is contained in $\text{int}D$ and that $B^2 \times 1$ contains D' in its interior. Reasoning as in Case 1, we see that $B^2 \times 0$ contains at least two endpoints of t , moreover $B^2 \times 1$ must contain at last three of them since it contains D' . As a consequence, the cylinder contains the entire tangle t .

Claim 8.8. *The cylinder $B^2 \times I$ is unknotted in \mathbf{B}^3 , and so the closure of the complement of the cylinder $B^2 \times I$ in \mathbf{B}^3 is a solid torus, V .*

Proof. Assume first that the endpoints of t_1 in D belong to $B^2 \times 0$. Then, since t_1 joins $\text{int}D$ with $\text{int}D'$, t_1 joins $B^2 \times 0$ with $B^2 \times 1$ in the cylinder $B^2 \times I$. So the cylinder $B^2 \times I$ is unknotted in \mathbf{B}^3 and hence the closure of its complement in \mathbf{B}^3 is a solid torus V .

Suppose that the above assumption does not hold. Then both endpoints of t_1 must belong to $B^2 \times 1$, while $B^2 \times 0$ contains precisely the two endpoints of t_2 . Consider now the disc δ_2 introduced before Lemma 8.4. Let η be a small arc contained in δ_2 and joining the point p of t_1 inside δ_2 to a point q in the interior of t_2 (see Figure 12). Let t'_2 any of the two subarcs of t_2 going from one of its endpoints to q and t'_1 the subarc of t_1 going from p to the endpoint of t_1 contained in D' . We claim that the arc obtained by concatenating t'_2 , η , and t'_1 is trivial and contained in the cylinder $B^2 \times I$. Indeed, this arc cobounds a disc with an arc in $\partial \mathbf{B}^3$: such disc is obtained by surgery along the two trivialising discs for t_1 and t_2 . To see that the arc is contained in the cylinder, it is enough to prove that η is contained inside the cylinder. This follows from the fact, that can be proved as in Claim 8.7, that δ_2 does not meet A . Using this trivial arc we see once more as in the previous case that the cylinder is unknotted and its exterior is a solid torus V . \square

By Claim 8.8, $(\mathbf{S}^3 \setminus \text{int}\mathbf{B}^3) \cup B^2 \times I$ is a solid torus, and $\partial B^2 \times 0$ is its meridian. Thus $\partial B^2 \times 0$ is a longitude of the solid torus V . So A is parallel to the annulus $A' := V \cap \partial \mathbf{B}^3$ through V . Since A is essential in $\mathbf{B}^3 \setminus t$, V should contain a component of t . This is, however, impossible for, as observed at the beginning, the entire tangle is contained in the cylinder.

Now the proof of Lemma 8.6 is complete. \square

Observe that the exterior of t in \mathbf{B}^3 is a genus 3 handlebody and so $\mathbf{B}^3 \setminus t$ is atoroidal (i.e., does not contain an essential torus). By using this fact and Lemmas 8.2-8.6, we can see that the link $\mathbf{S}^3 \setminus L_3$ is atoroidal. Since L_3 has 4 components, this implies that $\mathbf{S}^3 \setminus L_3$ cannot be a Seifert fibered space. Hence L_3 is hyperbolic by Thurston's uniformization theorem for Haken manifolds.

9. THE LINK L_6 IS HYPERBOLIC

Consider a fundamental domain for the action of the dihedral group of order 6 acting on (\mathbf{S}^3, L_6) and generated by the reflections in three vertical planes, as illustrated in Figure 4. The domain is shown in Figure 14.

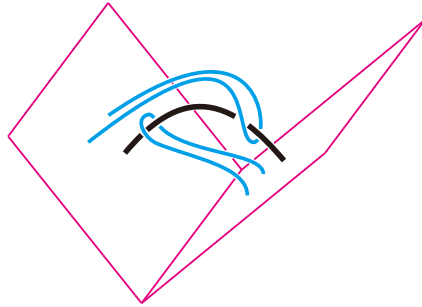

FIGURE 14. A local picture of the fundamental domain for the dihedral action on (\mathbf{S}^3, L_6) .

This domain can be seen as the intersection of two balls bounded by the fixed-point sets of two reflections, that is two 2-spheres. The two 2-spheres meet along a circle (a portion of the circle is the pink line of intersection of the two planes in Figure 14). It is not difficult to see that the tangle in this fundamental domain, together with the circle of intersection of the reflecting spheres on the boundary coincides with the tangle and the equator K_0 on the right-hand side of Figure 2. Doubling this tangle we then obtain the sublink \mathcal{O}_3 of the hyperbolic link L_3 , while the circle can be identified with K_0 .

Since L_3 is hyperbolic, it is also $2\pi/3$ -hyperbolic, for it is not the figure-eight knot. Indeed, it follows from Thurston's orbifold theorem (see [2, 7]) that a hyperbolic link that is not $2\pi/3$ -hyperbolic must be either Euclidean or spherical. Dunbar's list of geometric orbifolds with underlying space the 3-sphere [10] shows that the only link with this property is the figure-eight knot.

Consider now the hyperbolic orbifold $(\mathbf{S}^3, L_3(2\pi/3))$: it is topologically \mathbf{S}^3 with singular set L_3 of cone angle $2\pi/3$ along every component. The reflection γ_1 of L_3 induces a hyperbolic reflection of $(\mathbf{S}^3, L_3(2\pi/3))$ along a totally geodesic surface. This implies that the fundamental domain for the dihedral action admits a hyperbolic structure with cone angle $2\pi/3$ along the components of the tangle and cone angle $\pi/3$ along the circle cobounding the two totally-geodesic three-punctured discs of the silvered boundary.

This cone hyperbolic structure lifts now to a cone hyperbolic structure of L_6 . As a consequence, the link L_6 is $2\pi/3$ -hyperbolic and hence hyperbolic.

Remark 9.1. Since the link L_3 is $2\pi/n$ -hyperbolic for every $n \geq 3$, this construction provides a whole family of hyperbolic links obtained by gluing together $2n$ copies of the tangle in the fundamental domain, via reflections in half of their boundaries. The resulting link L_{2n} will admit a dihedral symmetry of order $2n$. If n is moreover odd, the link L_{2n} will also have the required \mathbb{G} -action to provide an admissible root.

Acknowledgements. The main bulk of this research was completed during a visit of the first named author to Hiroshima University in October 2017 funded by JSPS through FY2017 Invitational Fellowship for Research in Japan (short term). She is also thankful to the Hiroshima University Math Department for hospitality during her stay. The authors started discussing the contents of this work during a workshop held in Kyoto in 2011: they are grateful to the organisers, Teruaki Kitano and Takayuki Morifuji, for inviting them. They also thank Yasutaka Nakanishi for his helpful suggestions concerning the arguments in Sections 7 and 8.

REFERENCES

- [1] M. Boileau and E. Flapan, *Uniqueness of free action on S^3 respecting a knot*, Canad. J. Math. **39**, (1987), 969-982.
- [2] M. Boileau and J. Porti, *Geometrization of 3-orbifolds of cyclic type*, Astérisque Monograph, **272**, 2001.
- [3] M. Boileau and B. Zimmermann, *Symmetries of nonelliptic Montesinos links*, Math. Ann. **277**, (1987), 563-584.
- [4] F. Bonahon and L. Siebenmann, *The characteristic toric splitting of irreducible compact 3-orbifolds*, Math. Ann., **278**, (1987), 441-479.
- [5] F. Bonahon and L. Siebenmann, *New geometric splittings of classical knots, and the classification and symmetries of arborescent knots*, Draft of a monograph, available from <http://www-bcf.usc.edu/~fbonahon/Research/Preprints/Preprints.html>
- [6] G. Burde and K. Murasugi, *Links and Seifert fiber spaces*. Duke J. Math. **37** (1970), 89-93.
- [7] D. Cooper, C. Hodgson, and S. Kerckhoff, *Three-dimensional orbifolds and cone-manifolds*, MSJ Memoirs **5**, 2000.
- [8] M. Culler, N. Dunfield, and M. Goerner, *SnapPy*, Computer Software available at <https://www.math.uic.edu/t3m/SnapPy/>
- [9] J. Dinkelbach and B. Leeb, *Equivariant Ricci flow with surgery and applications to finite group actions on geometric 3-manifolds*, Geom. Topol. **13** (2009), 1129-1173.
- [10] W. Dunbar, *Geometric orbifolds* Rev. Mat. Univ. Complutense Madrid **1** (1988), 67-99.

- [11] D. Futer and F. Guéritaud, *Angled decompositions of arborescent link complements*, Proc. Lond. Math. Soc. (3) **98** (2009), 325-364.
- [12] N. Hoffman, K. Ichihara, M. Kashiwagi, H. Masai, S. Oishi, A. Takayasu, *Verified computations for hyperbolic 3-manifolds*, Exp. Math. **25** (2016), 66-78.
- [13] W. Jaco, *Lectures on three-manifold topology*, CBMS Regional Conference Series in Math., **43**. Mem. Amer. Math. Soc., Providence, R.I., 1980.
- [14] W. Jaco and P. Shalen, *Seifert fibered spaces in 3-manifolds*, Mem. Amer. Math. Soc **21** (1979), no.220,
- [15] A. Kawachi, *A survey of knot theory*, Birkhäuser, 1996.
- [16] K. W. Kwun, *Scarcity of orientation-reversing PL involutions of lens spaces*, Michigan Math. J. **17** (1970), 355-358.
- [17] D. Lee and M. Sakuma, *Epimorphisms between 2-bridge link groups: homotopically trivial simple loops on 2-bridge spheres*, Proc. Lond. Math. Soc. **104** (2012), 359-386.
- [18] W. Meeks and S.T. Yau, *The equivariant Dehn's lemma and loop theorem*, Comment. Math. Helv. **56** (1981), 225-239.
- [19] W. Menasco, *Closed incompressible surfaces in alternating knot and link complements*, Topology **23** (1984), 37-44.
- [20] J. Morgan and H. Bass, *The Smith conjecture*, Papers presented at the symposium held at Columbia University, New York, 1979, Pure and Applied Math., **112**. Academic Press, Inc., 1984.
- [21] R. Myers, *Excellent 1-manifolds in compact 3-manifolds*, Topology Appl. **49** (1993), 115-127.
- [22] R. Riley, *Seven excellent knots*, Low-dimensional topology (Bangor, 1979), pp.81-151, London Math. Soc. Lect. Note Ser. **48**, Cambridge Univ. Press, 1982.
- [23] M. Sakuma, *Periods of composite links*. Math. Sem. Notes, Kobe Univ. **9** (1981), 225-242.
- [24] M. Sakuma, *Uniqueness of symmetries of knots*. Math. Z. **192** (1986), 225-242.
- [25] M. Sakuma, *Non-free-periodicity of amphicheiral hyperbolic knots*, Homotopy theory and related topics, Adv. Stud. Pure Math. **9** (1987), 189-194.
- [26] M. Sakuma, *The geometries of spherical Montesinos links*, Kobe J. Math. **7** (1990), 167-190.
- [27] P. Scott, *The geometries of 3-manifolds*, Bull. London Math. Soc. **15** (1983), 401-487.
- [28] J. Weeks, *SnapPea*, Computer Software available at <http://www.geometrygames.org/SnapPea/>

AIX-MARSEILLE UNIV, CNRS, CENTRALE MARSEILLE, I2M, UMR 7373, 13453 MARSEILLE, FRANCE

E-mail address: luisa.paoluzzi@univ-amu.fr

DEPARTMENT OF MATHEMATICS, GRADUATE SCHOOL OF SCIENCE, HIROSHIMA UNIVERSITY, HIGASHI-HIROSHIMA, 739-8526, JAPAN

E-mail address: sakuma@hiroshima-u.ac.jp